



# ALLIED MACHINE & ENGINEERING

Holemaking Solutions for Today's Manufacturing



Drilling



Reaming



Burnishing



Threading



Specials



## Wohlhaupter®

▶ *BORING*

Rough Machining

**WOHLHAUPTER®**



SECTION

---

# B10-D

---

Rough Machining

# Wohlhaupter® Rough Machining

Twin Cutters | Chamfering Tools | Grooving Tools | Axial Grooving | Reverse Machining | VolCut

▶ Diameter Range: 0.768" - 9.645" (19.50 mm - 245.00 mm)



## Variety of tooling. Versatile operations.

A versatile range of tools for rough machining includes rough boring, chamfering, reverse machining, circular milling, and axial grooving. The insert holders with various insert pockets as well as height displaced insert holders are able to be easily adjusted for a quick setup process.

Your safety and the safety of others is very important. This catalog contains important safety messages. Always read and follow all safety precautions.



This triangle is a safety hazard symbol. It alerts you to potential safety hazards that can cause tool failure and serious injury.

When you see this symbol in the catalog, look for a related safety message that may be near this triangle or referred to in the nearby text.

There are safety signal words also used in the catalog. Safety messages follow these words.

### **WARNING**

**WARNING** (shown above) means that failure to follow the precautions in this message could result in tool failure and serious injury.

**NOTICE** means that failure to follow the precautions in this message could result in damage to the tool or machine but not result in personal injury.

**NOTE** and **IMPORTANT** are also used. These are important that you read and follow but are not safety-related.

Visit [www.alliedmachine.com](http://www.alliedmachine.com) for the most up-to-date information and procedures.

## Applicable Industries



Aerospace



Agriculture



Automotive



Firearms



General  
Machining



Oil & Gas



Renewable  
Energy

### Reference Icons

The following icons will appear throughout the catalog to help you navigate between products.

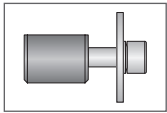

#### Clamping Elements

For use with insert holders and boring heads

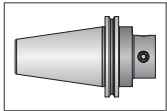

#### Shanks

A variety of shanks for different machines

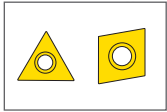

#### Inserts

For use with insert holder boring heads and boring bars using indexable inserts

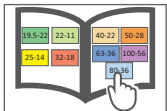

#### MVS Connection Color Guide

Detailed instructions and information regarding the MVS connection(s)

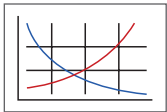

#### Recommended Cutting Data

Speed and feed recommendations for optimum and safe boring



#### Coolant-Through Option

Indicates that the product is coolant-through

## Rough Machining Table of Contents

### Introduction

Product Overview . . . . . 2 - 4

### Twin Cutters

Twin Cutters Same Level . . . . . 5 - 9

Twin Cutters Same Level Tangential Inserts. . . . . 10

Twin Cutters Height Displaced . . . . . 11 - 13

Twin Cutters Height Displaced Tangential Inserts. . . . . 14

### Chamfering

Chamfering Tools . . . . . 15 - 18

### Grooving

Grooving Tools for Circular Milling. . . . . 19

Axial Grooving Tools. . . . . 20

### Reverse Machining

Reverse Machining Tools. . . . . 21

### VolCut Tooling

VolCut Insert Holders. . . . . 22

VolCut Technical Information. . . . . 23

Accessories. . . . . 24

Series	Diameter Range	
	Imperial (inch)	Metric (mm)
Twin Cutters	0.768 - 8.071	19.50 - 205.00
Chamfering	0.748 - 8.504	19.00 - 216.00
Radial Grooving	0.787 - 3.110	20.00 - 79.00
Axial Grooving	0.787 - 8.071	20.00 - 205.00
Reverse Machining	1.142 - 9.646	29.00 - 245.00

# Rough Machining Product Preview

## Roughing Tools ROUGH MACHINING

### Versatile tools for a variety of applications.

- Diameter range: 0.768" - 9.646" (19.50 mm - 245.00 mm)
- Tangential inserts and insert holders also available
- Serrated tool bodies can be used for multiple applications including rough boring, chamfering, back boring, and axial grooving
- Insert holders can be used on large diameter Alu-Line serrated tool bodies and slides located in section G: 3.937" - 128.15" (100.00 mm - 3255.00 mm)

## Roughing Applications



- ▶ **Twin Cutter Assembly:**
  - (1) Reducer: 219087
  - (2) Serrated tool body: 148004
  - (3) Insert holders: 151004
  - (4) Inserts: 10408M158HC79



- ▶ **Tangential Cutter Assembly:**
  - (1) Shank: 353007
  - (2) Serrated tool body: 148005
  - (3) Insert holders: 151043
  - (4) Inserts: 00508M880HC198

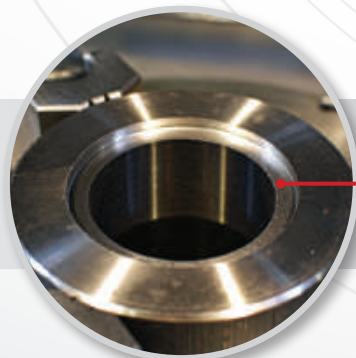

First Tangential Cut



► **Tangential Cutter Assembly:**

- (1) Shank: 353008
- (2) Serrated tool body: 148006
- (3) Insert holders: 151035
- (4) Inserts: 397594WHC198

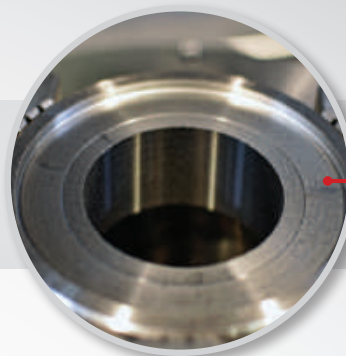

Second Tangential Cut



► **Axial Grooving Assembly:**

- (1) Shank: 353009
- (2) Serrated tool body: 148007
- (3) Support block: 226011
- (4) Insert holder: 226010
- (5) Insert: 297978WCH136

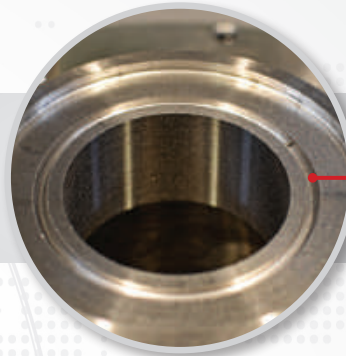

Axial Groove Cut



► **Chamfer Assembly:**

- (1) Shank: 353003
- (2) Serrated tool body: 148004
- (3) Insert holder: 201009
- (4) Inserts: 297497WHC79

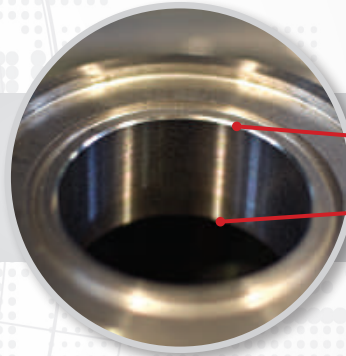

Top Chamfer

Bottom Chamfer

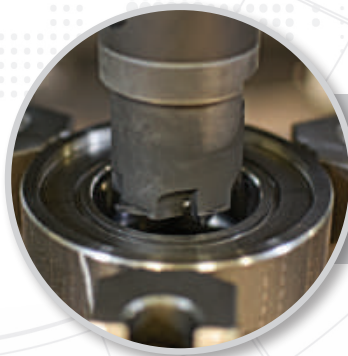

► **Radial Grooving Assembly:**

- (1) Shank: 353007
- (2) Grooving tool: 143055
- (3) Inserts: 097254WCH136

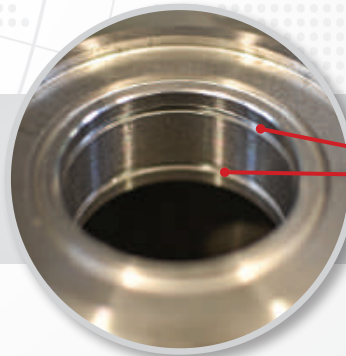

Grooves



► **Finished Application**

Case Study

Cycle time is crucial. Why not choose the best process?

Application: Ductile Cast Iron

Finish Diameter: 1.930" (49 mm)

Pre-Hole Diameter: 1.77" (45 mm)

Boring Depth: 8.23" (209 mm)



Measure	Rough 49mm Competitor 1.5" High Feed Milling Tool
Speed	1000 SFM (2500 RPM)
Feed Rate	0.020 IPT (153 IPM)
Total Passes	77
Cycle Time (per part)	<b>1.93 min</b>

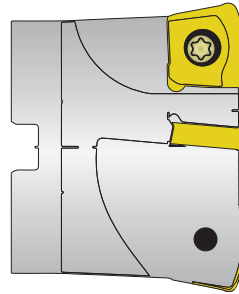

1.5" High Feed Milling Tool

OUR SOLUTION  
Wohlhaupter® Twin Cutter

Measure	Rough 49mm Wohlhaupter Twin Cutter
Speed	500 SFM (900 RPM)
Feed Rate	0.012 IPR (11.88 IPM)
Total Passes	1
Cycle Time (per part)	<b>0.69 min</b>

- ▶ Twin Cutter assembly:
  - (1) Insert Holders (x2): 151023
  - (2) Serrated tool body: 148018
  - (3) Shank: 353015

- Boring inserts
- ▶ Item No.: 297239WHC79

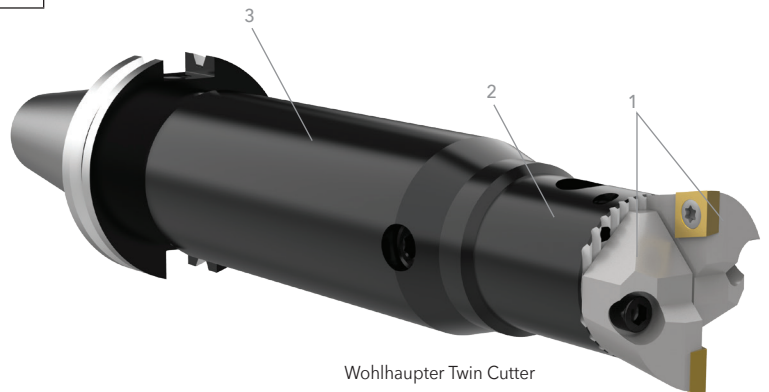

Wohlhaupter Twin Cutter

A  
B  
C  
D  
E  
F  
G  
H  
I  
J  
K  
L  
M  
INDEX



### Twin Cutters Same Level

90° | Diameter Range: 0.768" - 1.181" (19.50 mm - 30.00 mm)

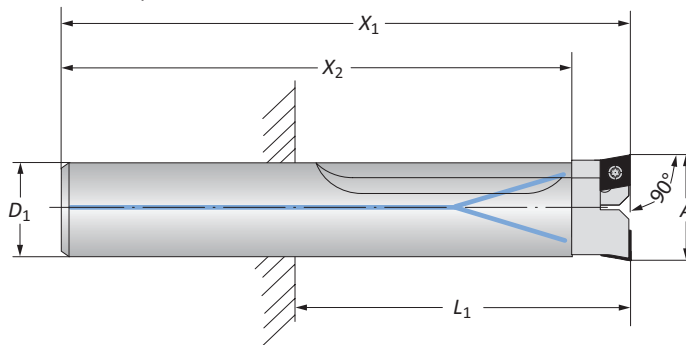

#### Twin Cutters Same Level

	Connection	Boring Range	Twin Cutter			Weight	Insert Form	Part No.	
	$D_1$	A	$X_1$	$X_2$	$L_1$			Insert Holder	Serrated Body
<b>i</b>	18	0.768 - 0.906	5.910	5.433	3.149	0.661 (lbs)	101	235031	235021
	20	0.886 - 1.024	5.910	5.433	3.543	0.661 (lbs)	101	235032	235022
	23	1.004 - 1.181	6.299	5.826	3.937	0.661 (lbs)	101	235033	235023
<b>m</b>	18	19.50 - 23.00	150.00	138.00	80.00	0.30 (kg)	101	235031	235021
	20	22.50 - 26.00	150.00	138.00	90.00	0.30 (kg)	101	235032	235022
	23	25.50 - 30.00	160.00	148.00	100.00	0.30 (kg)	101	235033	235023

**NOTE:** Insert holders sold in quantities of 1, and inserts sold separately

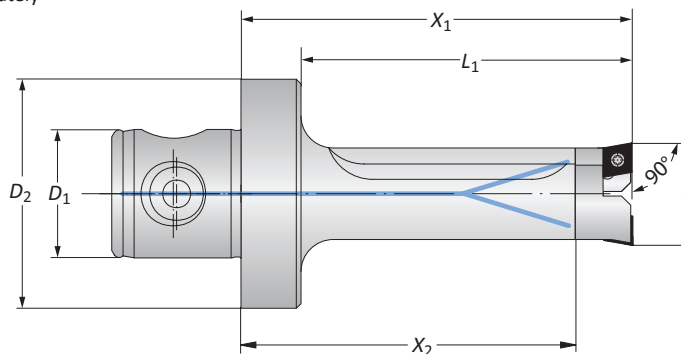

#### Twin Cutters Same Level

	Connection	Boring Range	Twin Cutter			Weight	Insert Form	Part No.	
	$D_2   D_1$	A	$X_1$	$X_2$	$L_1$			Insert Holder	Serrated Body
<b>i</b>	50 - 28	0.768 - 0.906	3.346	2.874	2.834	0.881 (lbs)	101	235031	235001
	50 - 28	0.886 - 1.024	3.543	3.070	3.031	1.102 (lbs)	101	235032	235002
	50 - 28	1.004 - 1.181	3.740	3.268	3.228	1.102 (lbs)	101	235033	235003
	63 - 36	0.768 - 0.906	3.346	2.874	2.834	1.543 (lbs)	101	235031	235011
	63 - 36	0.886 - 1.024	3.543	3.070	3.031	1.543 (lbs)	101	235032	235012
	63 - 36	1.004 - 1.181	3.740	3.268	3.228	1.843 (lbs)	101	235033	235013
<b>m</b>	50 - 28	19.50 - 23.00	85.00	73.00	72.00	0.40 (kg)	101	235031	235001
	50 - 28	22.50 - 26.00	90.00	78.00	77.00	0.50 (kg)	101	235032	235002
	50 - 28	25.50 - 30.00	95.00	83.00	82.00	0.50 (kg)	101	235033	235003
	63 - 36	19.50 - 23.00	85.00	73.00	72.00	0.70 (kg)	101	235031	235011
	63 - 36	22.50 - 26.00	90.00	78.00	77.00	0.70 (kg)	101	235032	235012
	63 - 36	25.50 - 30.00	95.00	83.00	82.00	0.83 (kg)	101	235033	235013

**NOTE:** Insert holders sold in quantities of 1, and inserts sold separately

B10-M: 12-15

B10-D: 24

B10-F

B10-H

B10: vi-vii

**i** = Imperial (in)  
**m** = Metric (mm)

Inserts sold separately

**IMPORTANT:** Max spindle speed refers to maximum possible speed for an individual boring head and is not a recommended parameter. Refer to page B10-M: 12 for recommended application-specific parameters. Factory technical assistance is available for your specific applications through our Application Engineering department.  
ext: 7611 | email: [appeng@alliedmachine.com](mailto:appeng@alliedmachine.com)

## Twin Cutters Same Level

90° | 5xD | Diameter Range: 1.142" - 2.598" (29.00 mm - 66.00 mm)

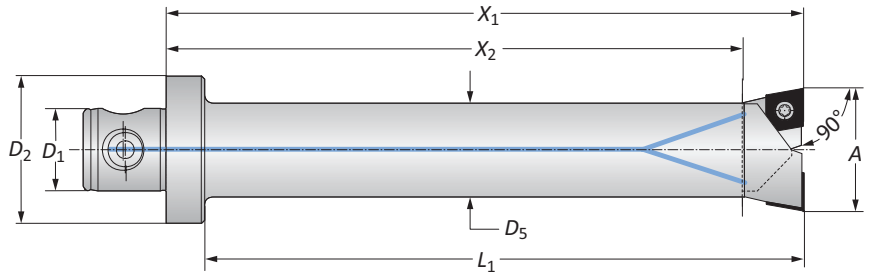

	Connection	Boring Range	Twin Cutter				Weight	Insert Form	Part No.	
			$D_2   D_1$	A	$X_1$	$X_2$			$L_1$	$D_5$
i	50 - 28	1.142 - 1.457	6.102	5.551	5.590	1.023	1.984 (lbs)	103	151001	148021
	50 - 28	1.417 - 1.732	6.889	6.338	6.377	1.259	2.866 (lbs)	103	151002	148022
	50 - 28	1.693 - 2.126	8.465	7.677	7.952	1.456	4.188 (lbs)	103	151023	148023
	50 - 28	1.693 - 2.126	8.465	7.677	7.952	1.456	4.188 (lbs)	104	151003	148023
	50 - 28	2.087 - 2.598	8.465	7.677	7.952	1.732	5.511 (lbs)	103	151024	148024
	50 - 28	2.087 - 2.598	8.465	7.677	7.952	1.732	5.511 (lbs)	104	151004	148024
m	50 - 28	29.00 - 37.00	155.00	141.00	142.00	26.00	0.90 (kg)	103	151001	148021
	50 - 28	36.00 - 44.00	175.00	161.00	162.00	32.00	1.30 (kg)	103	151002	148022
	50 - 28	43.00 - 54.00	215.00	195.00	202.00	37.00	1.90 (kg)	103	151023	148023
	50 - 28	43.00 - 54.00	215.00	195.00	202.00	37.00	1.90 (kg)	104	151003	148023
	50 - 28	53.00 - 66.00	215.00	195.00	202.00	44.00	2.50 (kg)	103	151024	148024
	50 - 28	53.00 - 66.00	215.00	195.00	202.00	44.00	2.50 (kg)	104	151004	148024

NOTE: Different lengths available upon request.

NOTE: Insert holders sold in quantities of 1, and inserts sold separately

B10-M: 12-15

B10-D: 24

B10-F

B10-H

B10: vi-vii

i = Imperial (in)  
m = Metric (mm)

Inserts sold separately

**IMPORTANT:** Max spindle speed refers to maximum possible speed for an individual boring head and is not a recommended parameter. Refer to page B10-M: 12 for recommended application-specific parameters. Factory technical assistance is available for your specific applications through our Application Engineering department.

ext: 7611 | email: [appeng@alliedmachine.com](mailto:appeng@alliedmachine.com)

## Twin Cutters Same Level

90° | Diameter Range: 1.142" - 4.055" (29.00 mm - 103.00 mm)

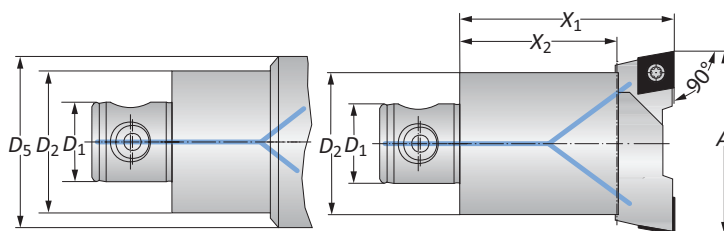
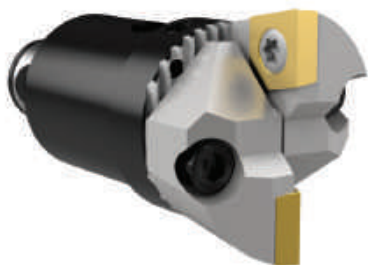

Connection	Boring Range	Twin Cutter			Weight	Insert Form	Part No.		
		$D_2   D_1$	A	$X_1$			$X_2$	$D_5$	Insert Holder
i	25 - 14	1.142 - 1.457	2.205	1.653	-	0.441 (lbs)	103	151001	148001
	25 - 14	1.417 - 1.732	2.205	1.653	1.811	0.441 (lbs)	103	151002	148002
	32 - 18	1.417 - 1.732	2.205	1.653	1.811	0.881 (lbs)	103	151002	148017
	32 - 18	1.693 - 2.126	2.598	1.811	1.417	0.881 (lbs)	103	151023	148003
	32 - 18	1.693 - 2.126	2.598	1.811	1.417	0.881 (lbs)	104	151003	148003
	40 - 22	1.693 - 2.126	2.598	1.811	1.417	1.543 (lbs)	103	151023	148018
	40 - 22	1.693 - 2.126	2.598	1.811	1.417	1.543 (lbs)	104	151003	148018
	40 - 22	2.087 - 2.598	2.953	2.165	-	1.543 (lbs)	103	151024	148004
	40 - 22	2.087 - 2.598	2.953	2.165	-	1.543 (lbs)	104	151004	148004
	50 - 28	2.559 - 3.268	2.953	2.165	-	2.425 (lbs)	103	151025	148005
	50 - 28	2.559 - 3.268	2.953	2.165	-	2.425 (lbs)	104	151005	148005
	63 - 36	3.228 - 4.055	3.543	2.362	-	4.188 (lbs)	103	151026	148006
	63 - 36	3.228 - 4.055	3.543	2.362	-	4.188 (lbs)	104	151086	148006
	63 - 36	3.228 - 4.055	3.543	2.362	-	4.188 (lbs)	105	151006	148006
m	25 - 14	29.00 - 37.00	56.00	42.00	-	0.20 (kg)	103	151001	148001
	25 - 14	36.00 - 44.00	56.00	42.00	30.00	0.20 (kg)	103	151002	148002
	32 - 18	36.00 - 44.00	56.00	42.00	30.00	0.40 (kg)	103	151002	148017
	32 - 18	43.00 - 54.00	66.00	46.00	36.00	0.40 (kg)	103	151023	148003
	32 - 18	43.00 - 54.00	66.00	46.00	36.00	0.40 (kg)	104	151003	148003
	40 - 22	43.00 - 54.00	66.00	46.00	36.00	0.70 (kg)	103	151023	148018
	40 - 22	43.00 - 54.00	66.00	46.00	36.00	0.70 (kg)	104	151003	148018
	40 - 22	53.00 - 66.00	75.00	55.00	-	0.70 (kg)	103	151024	148004
	40 - 22	53.00 - 66.00	75.00	55.00	-	0.70 (kg)	104	151004	148004
	50 - 28	65.00 - 83.00	75.00	55.00	-	1.10 (kg)	103	151025	148005
	50 - 28	65.00 - 83.00	75.00	55.00	-	1.10 (kg)	104	151005	148005
	63 - 36	82.00 - 103.00	90.00	60.00	-	1.90 (kg)	103	151026	148006
	63 - 36	82.00 - 103.00	90.00	60.00	-	1.90 (kg)	104	151086	148006
	63 - 36	82.00 - 103.00	90.00	60.00	-	1.90 (kg)	105	151006	148006

NOTE: Insert holders sold in quantities of 1, and inserts sold separately

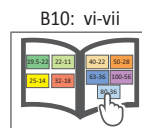
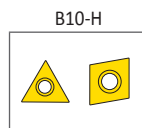
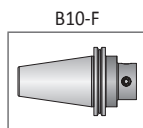
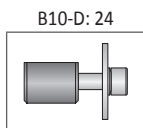
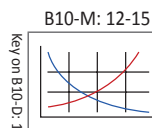

i = Imperial (in)  
m = Metric (mm)

Inserts sold separately

**IMPORTANT:** Max spindle speed refers to maximum possible speed for an individual boring head and is not a recommended parameter. Refer to page B10-M: 12 for recommended application-specific parameters. Factory technical assistance is available for your specific applications through our Application Engineering department.  
ext: 7611 | email: [appeng@alliedmachine.com](mailto:appeng@alliedmachine.com)

## Twin Cutters Same Level

90° | Diameter Range: 3.937" - 8.071" (100.00 mm - 205.00 mm)

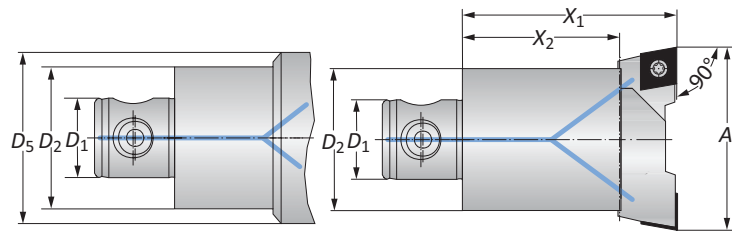

	Connection	Boring Range	Twin Cutter			Weight	Insert Form	Part No.	
	D <sub>2</sub>   D <sub>1</sub>	A	X <sub>1</sub>	X <sub>2</sub>	D <sub>5</sub>			Insert Holder	Serrated Body
i	80 - 36	3.937 - 5.118	3.543	2.362	-	6.613 (lbs)	103	151027	148007
	80 - 36	3.937 - 5.118	3.543	2.362	-	6.613 (lbs)	104	151087	148007
	80 - 36	3.937 - 5.118	3.543	2.362	-	6.613 (lbs)	105	151007	148007
	80 - 36	4.921 - 6.102	3.543	2.362	-	7.054 (lbs)	103	151028	148007
	80 - 36	4.921 - 6.102	3.543	2.362	-	7.054 (lbs)	104	151088	148007
	80 - 36	4.921 - 6.102	3.543	2.362	-	7.054 (lbs)	105	151008	148007
	80 - 36	5.906 - 8.071	3.543	2.362	4.921	8.818 (lbs)	103	151028	148009
	80 - 36	5.906 - 8.071	3.543	2.362	4.921	8.818 (lbs)	104	151088	148009
	80 - 36	5.906 - 8.071	3.543	2.362	4.921	8.818 (lbs)	105	151008	148009
m	80 - 36	100.00 - 130.00	90.00	60.00	-	3.00 (kg)	103	151027	148007
	80 - 36	100.00 - 130.00	90.00	60.00	-	3.00 (kg)	104	151087	148007
	80 - 36	100.00 - 130.00	90.00	60.00	-	3.00 (kg)	105	151007	148007
	80 - 36	125.00 - 155.00	90.00	60.00	-	3.20 (kg)	103	151028	148007
	80 - 36	125.00 - 155.00	90.00	60.00	-	3.20 (kg)	104	151088	148007
	80 - 36	125.00 - 155.00	90.00	60.00	-	3.20 (kg)	105	151008	148007
	80 - 36	150.00 - 205.00	90.00	60.00	125.00	4.00 (kg)	103	151028	148009
	80 - 36	150.00 - 205.00	90.00	60.00	125.00	4.00 (kg)	104	151088	148009
	80 - 36	150.00 - 205.00	90.00	60.00	125.00	4.00 (kg)	105	151008	148009

NOTE: Insert holders sold in quantities of 1, and inserts sold separately

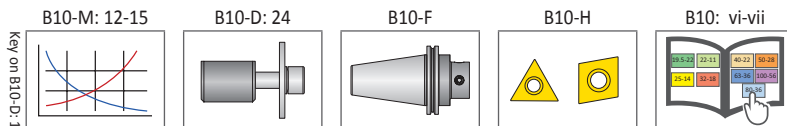

i = Imperial (in)  
m = Metric (mm)

Inserts sold separately

**IMPORTANT:** Max spindle speed refers to maximum possible speed for an individual boring head and is not a recommended parameter. Refer to page B10-M: 12 for recommended application-specific parameters. Factory technical assistance is available for your specific applications through our Application Engineering department.  
ext: 7611 | email: [appeng@alliedmachine.com](mailto:appeng@alliedmachine.com)

## Twin Cutters Same Level

80° | Diameter Range: 1.142" - 8.071" (29.00 mm - 205.00 mm)

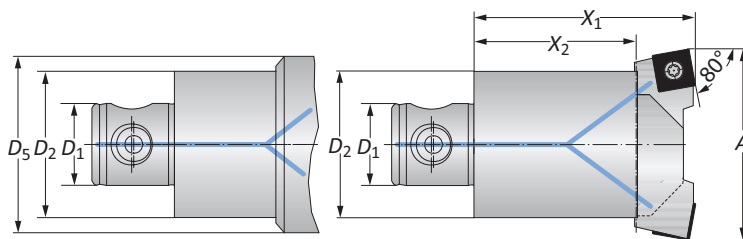

	Connection	Boring Range	Twin Cutter			Weight	Insert Form	Part No.	
	D <sub>2</sub>   D <sub>1</sub>	A	X <sub>1</sub>	X <sub>2</sub>	D <sub>5</sub>			Insert Holder	Serrated Tool Body
i	25 - 14	1.142 - 1.457	2.205	1.653	-	0.440 (lbs)	112	151011	148001
	25 - 14	1.417 - 1.732	2.205	1.653	1.181	0.440 (lbs)	112	151012	148002
	32 - 18	1.417 - 1.732	2.441	1.653	1.181	0.881 (lbs)	112	151012	148017
	32 - 18	1.693 - 2.126	2.598	1.811	1.417	0.440 (lbs)	113	151013	148003
	40 - 22	1.693 - 2.126	2.598	1.811	1.417	1.543 (lbs)	113	151013	148018
	40 - 22	2.087 - 2.598	2.952	2.165	-	1.543 (lbs)	113	151014	148004
	50 - 28	2.559 - 3.268	2.952	2.165	-	2.425 (lbs)	113	151015	148005
	63 - 36	3.228 - 4.055	3.543	2.362	-	5.070 (lbs)	113	151036	148006
	80 - 36	3.937 - 5.118	3.543	2.362	-	6.613 (lbs)	113	151037	148007
	80 - 36	4.921 - 6.102	3.543	2.362	-	7.054 (lbs)	113	151038	148007
80 - 36	5.906 - 8.071	3.543	2.362	4.921	8.818 (lbs)	113	151038	148009	
m	25 - 14	29.00 - 37.00	56.00	42.00	-	0.20 (kg)	112	151011	148001
	25 - 14	36.00 - 44.00	56.00	42.00	30.00	0.20 (kg)	112	151012	148002
	32 - 18	36.00 - 44.00	62.00	42.00	30.00	0.40 (kg)	112	151012	148017
	32 - 18	43.00 - 54.00	66.00	46.00	36.00	0.40 (kg)	113	151013	148003
	40 - 22	43.00 - 54.00	66.00	46.00	36.00	0.70 (kg)	113	151013	148018
	40 - 22	53.00 - 66.00	75.00	55.00	-	0.70 (kg)	113	151014	148004
	50 - 28	65.00 - 83.00	75.00	55.00	-	1.10 (kg)	113	151015	148005
	63 - 36	82.00 - 103.00	90.00	60.00	-	2.30 (kg)	113	151036	148006
	80 - 36	100.00 - 130.00	90.00	60.00	-	3.00 (kg)	113	151037	148007
	80 - 36	125.00 - 155.00	90.00	60.00	-	3.20 (kg)	113	151038	148007
80 - 36	150.00 - 205.00	90.00	60.00	125.00	4.00 (kg)	113	151038	148009	

NOTE: Insert holders sold in quantities of 1, and inserts sold separately

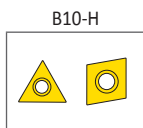
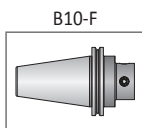
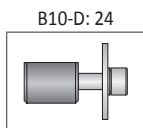
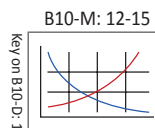

i = Imperial (in)  
m = Metric (mm)

Inserts sold separately

**IMPORTANT:** Max spindle speed refers to maximum possible speed for an individual boring head and is not a recommended parameter. Refer to page B10-M: 12 for recommended application-specific parameters. Factory technical assistance is available for your specific applications through our Application Engineering department.

ext: 7611 | email: [appeng@alliedmachine.com](mailto:appeng@alliedmachine.com)

## Twin Cutters Same Level Tangential Inserts

Diameter Range: 2.087" - 8.071" (53.00 mm - 205.00 mm)

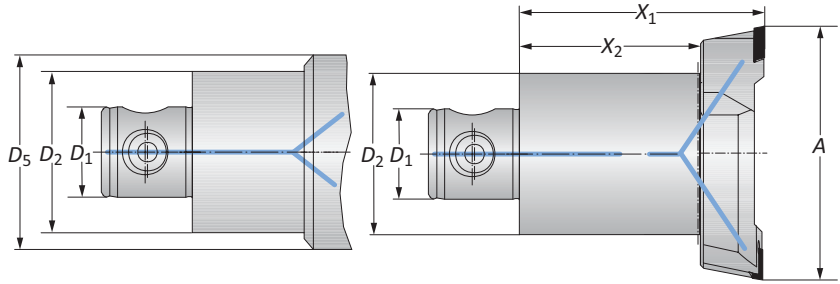

	Connection	Boring Range	Twin Cutter			Weight	Insert Form	Part No.	
	$D_2   D_1$	A	$X_1$	$X_2$	$D_5$			Insert Holder	Serrated Body
i	40 - 22	2.087 - 2.598	2.953	2.165	-	1.543 (lbs)	04	151022	148004
	50 - 28	2.559 - 3.268	2.953	2.165	-	2.204 (lbs)	04	151032	148005
	50 - 28	2.559 - 3.268	2.953	2.165	-	2.204 (lbs)	05	151043	148005
	63 - 36	3.228 - 4.055	3.543	2.362	-	4.850 (lbs)	05	151035	148006
	80 - 36	3.937 - 5.118	3.543	2.362	-	6.613 (lbs)	05	151009	148007
	80 - 36	4.921 - 6.102	3.543	2.362	-	6.843 (lbs)	05	151010	148007
	80 - 36	5.906 - 8.071	3.543	2.362	4.921	8.818 (lbs)	05	151010	148009
m	40 - 22	53.00 - 66.00	75.00	55.00	-	0.70 (kg)	04	151022	148004
	50 - 28	65.00 - 83.00	75.00	55.00	-	1.00 (kg)	04	151032	148005
	50 - 28	65.00 - 83.00	75.00	55.00	-	1.00 (kg)	05	151043	148005
	63 - 36	82.00 - 103.00	90.00	60.00	-	2.20 (kg)	05	151035	148006
	80 - 36	100.00 - 130.00	90.00	60.00	-	3.00 (kg)	05	151009	148007
	80 - 36	125.00 - 155.00	90.00	60.00	-	3.10 (kg)	05	151010	148007
	80 - 36	150.00 - 205.00	90.00	60.00	125.00	4.00 (kg)	05	151010	148009

NOTE: Insert holders sold in quantities of 1, and inserts sold separately

Key on B10-D-1

B10-M: 12-15

B10-D: 24

B10-F

B10-H

B10: vi-vii

i = Imperial (in)  
m = Metric (mm)

Inserts sold separately

**IMPORTANT:** Max spindle speed refers to maximum possible speed for an individual boring head and is not a recommended parameter. Refer to page B10-M: 12 for recommended application-specific parameters. Factory technical assistance is available for your specific applications through our Application Engineering department.  
ext: 7611 | email: [appeng@alliedmachine.com](mailto:appeng@alliedmachine.com)

### Twin Cutters Height Displaced

90° | Diameter Range: 1.142" - 4.055" (29.00 mm - 103.00 mm)

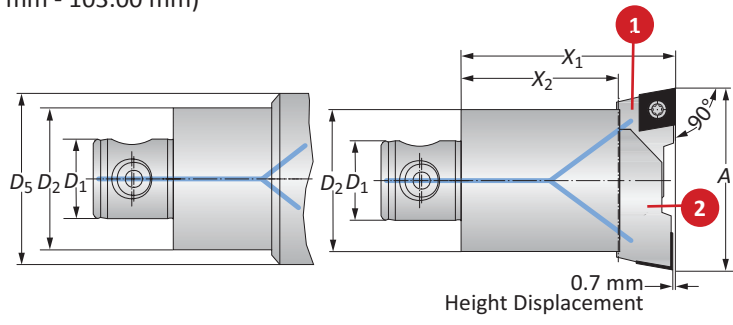
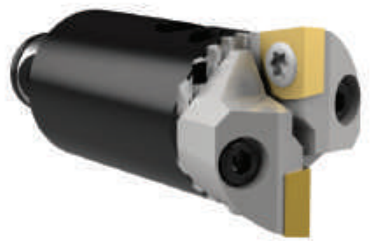

Connection	Boring Range	Twin Cutter				Weight	Insert Form	Part No.		
		$D_2   D_1$	A	$X_1$	$X_2$			$D_5$	1 Insert Holder	2. Insert Holder (-0.7mm)
i	25 - 14	1.142 - 1.457	2.205	1.653	-	0.440 (lbs)	103	151001	151061	148001
	25 - 14	1.417 - 1.732	2.205	1.653	1.181	0.440 (lbs)	103	151002	151062	148002
	32 - 18	1.417 - 1.732	2.205	1.653	1.181	0.881 (lbs)	103	151002	151062	148017
	32 - 18	1.693 - 2.126	2.598	1.811	1.417	0.881 (lbs)	104	151003	151093	148003
	40 - 22	1.693 - 2.126	2.598	1.811	1.417	1.543 (lbs)	104	151003	151093	148018
	40 - 22	2.087 - 2.598	2.953	2.165	-	1.543 (lbs)	104	151004	151094	148004
	50 - 28	2.559 - 3.268	2.953	2.165	-	2.425 (lbs)	104	151005	151095	148005
	63 - 36	3.228 - 4.055	3.543	2.362	-	5.291 (lbs)	104	151086	151090	148006
63 - 36	3.228 - 4.055	3.543	2.362	-	5.291 (lbs)	105	151006	151096	148006	
m	25 - 14	29.00 - 37.00	56.00	42.00	-	0.20 (kg)	103	151001	151061	148001
	25 - 14	36.00 - 44.00	56.00	42.00	30.00	0.20 (kg)	103	151002	151062	148002
	32 - 18	36.00 - 44.00	56.00	42.00	30.00	0.40 (kg)	103	151002	151062	148017
	32 - 18	43.00 - 54.00	66.00	46.00	36.00	0.40 (kg)	104	151003	151093	148003
	40 - 22	43.00 - 54.00	66.00	46.00	36.00	0.70 (kg)	104	151003	151093	148018
	40 - 22	53.00 - 66.00	75.00	55.00	-	0.70 (kg)	104	151004	151094	148004
	50 - 28	65.00 - 83.00	75.00	55.00	-	1.10 (kg)	104	151005	151095	148005
	63 - 36	82.00 - 103.00	90.00	60.00	-	2.40 (kg)	104	151086	151090	148006
63 - 36	82.00 - 103.00	90.00	60.00	-	2.40 (kg)	105	151006	151096	148006	

NOTE: Insert holders sold in quantities of 1, and inserts sold separately

B10-M: 12-15

B10-D: 24

B10-F

B10-H

B10: vi-vii

i = Imperial (in)  
m = Metric (mm)

Inserts sold separately

**IMPORTANT:** Max spindle speed refers to maximum possible speed for an individual boring head and is not a recommended parameter. Refer to page B10-M: 12 for recommended application-specific parameters. Factory technical assistance is available for your specific applications through our Application Engineering department.  
ext: 7611 | email: [appeng@alliedmachine.com](mailto:appeng@alliedmachine.com)

## Twin Cutters Height Displaced

90° | 5xD | Diameter Range: 1.142" - 2.598" (29.00 mm - 66.00 mm)

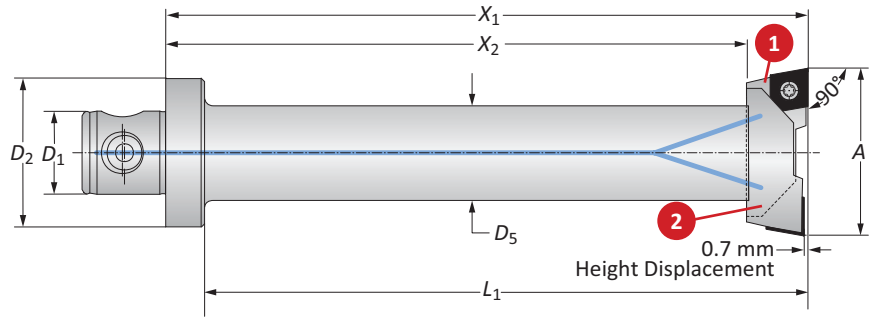

	Connection	Boring Range	Twin Cutter				Weight	Insert Form	Part No.		
			D <sub>2</sub>   D <sub>1</sub>	A	X <sub>1</sub>	X <sub>2</sub>			L <sub>1</sub>	D <sub>5</sub>	1. Insert Holder
i	50 - 28	1.142 - 1.457	6.102	5.551	5.590	1.023	1.984 (lbs)	103	151001	151061	148021
	50 - 28	1.417 - 1.732	6.889	6.338	6.377	1.259	2.866 (lbs)	103	151002	151062	148022
	50 - 28	1.693 - 2.126	8.465	7.677	7.952	1.456	4.188 (lbs)	104	151003	151093	148023
	50 - 28	2.087 - 2.598	8.465	7.677	7.951	1.732	5.511 (lbs)	104	151004	151094	148024
m	50 - 28	29.00 - 37.00	155.00	141.00	142.00	26.00	0.90 (kg)	103	151001	151061	148021
	50 - 28	36.00 - 44.00	175.00	161.00	162.00	32.00	1.30 (kg)	103	151002	151062	148022
	50 - 28	43.00 - 54.00	215.00	195.00	202.00	37.00	1.90 (kg)	104	151003	151093	148023
	50 - 28	53.00 - 66.00	215.00	195.00	202.00	44.00	2.50 (kg)	104	151004	151094	148024

NOTE: Different lengths available upon request.

NOTE: Insert holders sold in quantities of 1, and inserts sold separately

Key on B10-D-1

B10-M: 12-15

B10-D: 24

B10-F

B10-H

B10: vi-vii

i = Imperial (in)  
m = Metric (mm)

Inserts sold separately

**IMPORTANT:** Max spindle speed refers to maximum possible speed for an individual boring head and is not a recommended parameter. Refer to page B10-M: 12 for recommended application-specific parameters. Factory technical assistance is available for your specific applications through our Application Engineering department.  
ext: 7611 | email: [appeng@alliedmachine.com](mailto:appeng@alliedmachine.com)



## Twin Cutters Height Displaced

90° | Diameter Range: 3.937" - 8.071" (100.00 mm - 205.00 mm)

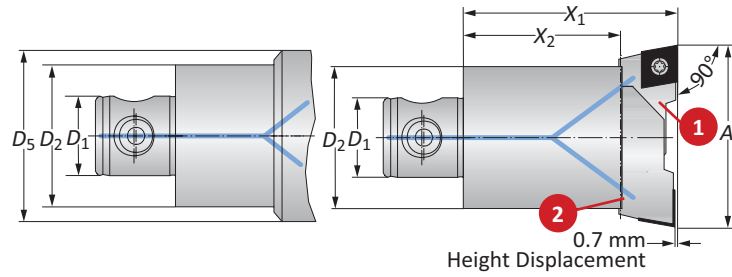

	Connection	Boring Range	Twin Cutter			Weight	Insert Form	Part No.		
			$D_2   D_1$	A	$X_1$			$X_2$	$D_5$	1. Insert Holder
<b>i</b>	80 - 36	3.937 - 5.118	3.543	2.362	-	6.613 (lbs)	104	<b>151087</b>	<b>151091</b>	<b>148007</b>
	80 - 36	3.937 - 5.118	3.543	2.362	-	6.613 (lbs)	105	<b>151007</b>	<b>151097</b>	<b>148007</b>
	80 - 36	4.921 - 6.102	3.543	2.362	-	7.054 (lbs)	104	<b>151088</b>	<b>151092</b>	<b>148007</b>
	80 - 36	4.921 - 6.102	3.543	2.362	-	7.054 (lbs)	105	<b>151008</b>	<b>151098</b>	<b>148007</b>
	80 - 36	5.906 - 8.071	3.543	2.362	4.921	8.818 (lbs)	104	<b>151088</b>	<b>151092</b>	<b>148009</b>
	80 - 36	5.906 - 8.071	3.543	2.362	4.921	8.818 (lbs)	105	<b>151008</b>	<b>151098</b>	<b>148009</b>
<b>m</b>	80 - 36	100.00 - 130.00	90.00	60.00	-	3.00 (kg)	104	<b>151087</b>	<b>151091</b>	<b>148007</b>
	80 - 36	100.00 - 130.00	90.00	60.00	-	3.00 (kg)	105	<b>151007</b>	<b>151097</b>	<b>148007</b>
	80 - 36	125.00 - 155.00	90.00	60.00	-	3.20 (kg)	104	<b>151088</b>	<b>151092</b>	<b>148007</b>
	80 - 36	125.00 - 155.00	90.00	60.00	-	3.20 (kg)	105	<b>151008</b>	<b>151098</b>	<b>148007</b>
	80 - 36	150.00 - 205.00	90.00	60.00	125.00	4.00 (kg)	104	<b>151088</b>	<b>151092</b>	<b>148009</b>
	80 - 36	150.00 - 205.00	90.00	60.00	125.00	4.00 (kg)	105	<b>151008</b>	<b>151098</b>	<b>148009</b>

**NOTE:** Insert holders sold in quantities of 1, and inserts sold separately

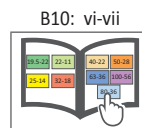
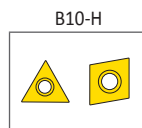
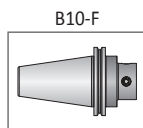
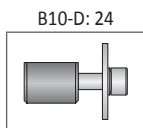
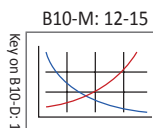

**i** = Imperial (in)

**m** = Metric (mm)

Inserts sold separately

**IMPORTANT:** Max spindle speed refers to maximum possible speed for an individual boring head and is not a recommended parameter. Refer to page B10-M: 12 for recommended application-specific parameters. Factory technical assistance is available for your specific applications through our Application Engineering department.

ext: 7611 | email: [appeng@alliedmachine.com](mailto:appeng@alliedmachine.com)

A  
B  
C  
D  
E  
F  
G  
H  
I  
J  
K  
L  
M  
INDEX

## Twin Cutters Height Displaced Tangential Inserts

Diameter Range: 2.087" - 8.071" (53.00 mm - 205.00 mm)

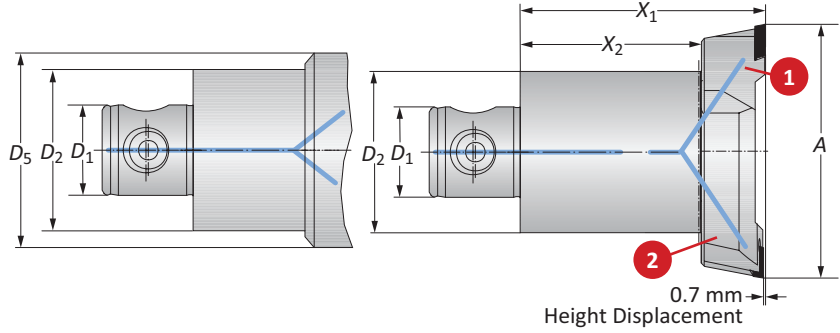

	Connection	Boring Range	Twin Cutter			Weight	Insert Form	Part No.		
	D <sub>2</sub>   D <sub>1</sub>	A	X <sub>1</sub>	X <sub>2</sub>	D <sub>5</sub>			1. Insert Holder	2. Insert Holder (-0.7mm)	Serrated Body
i	40 - 22	2.087 - 2.598	2.953	2.165	-	1.543 (lbs)	04	151022	268009	148004
	50 - 28	2.559 - 3.268	2.953	2.165	-	2.204 (lbs)	04	151032	268010	148005
	50 - 28	2.559 - 3.268	2.953	2.165	-	2.204 (lbs)	05	151043	268019	148005
	63 - 36	3.229 - 4.055	3.543	2.362	-	5.291 (lbs)	04	151034	268020	148006
	63 - 36	3.229 - 4.055	3.543	2.362	-	5.291 (lbs)	05	151035	268021	148006
	80 - 36	3.937 - 5.118	3.543	2.362	-	6.613 (lbs)	05	151009	268022	148007
	80 - 36	4.921 - 6.102	3.543	2.362	-	6.834 (lbs)	05	151010	268023	148007
	80 - 36	5.906 - 8.071	3.543	2.362	4.921	8.818 (lbs)	05	151010	268023	148009
m	40 - 22	53.00 - 66.00	75.00	55.00	-	0.70 (kg)	04	151022	268009	148004
	50 - 28	65.00 - 83.00	75.00	55.00	-	1.00 (kg)	04	151032	268010	148005
	50 - 28	65.00 - 83.00	75.00	55.00	-	1.00 (kg)	05	151043	268019	148005
	63 - 36	82.00 - 103.00	90.00	60.00	-	2.20 (kg)	04	151034	268020	148006
	63 - 36	82.00 - 103.00	90.00	60.00	-	2.20 (kg)	05	151035	268021	148006
	80 - 36	100.00 - 130.00	90.00	60.00	-	3.00 (kg)	05	151009	268022	148007
	80 - 36	125.00 - 155.00	90.00	60.00	-	3.10 (kg)	05	151010	268023	148007
	80 - 36	150.00 - 205.00	90.00	60.00	125.00	4.00 (kg)	05	151010	268023	148009

NOTE: Insert holders sold in quantities of 1, and inserts sold separately

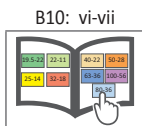
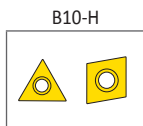
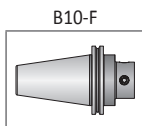
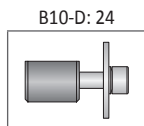
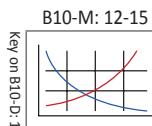

i = Imperial (in)  
m = Metric (mm)

Inserts sold separately

**IMPORTANT:** Max spindle speed refers to maximum possible speed for an individual boring head and is not a recommended parameter. Refer to page B10-M: 12 for recommended application-specific parameters. Factory technical assistance is available for your specific applications through our Application Engineering department.  
ext: 7611 | email: [appeng@alliedmachine.com](mailto:appeng@alliedmachine.com)

## Chamfering Tools

Diameter Range: 0.787" - 1.260" (20.00 mm - 32.00 mm)

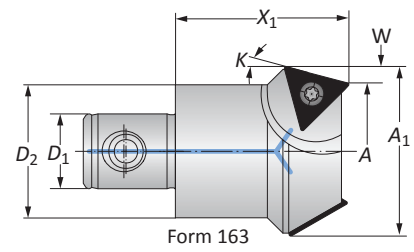
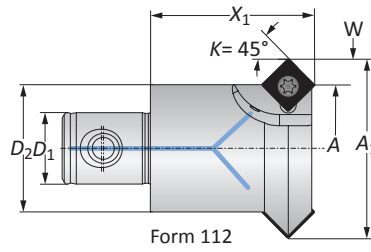

Connection	Approach Angle	Boring Range	Cutter Diameter	Chamfering Tool		Weight	Insert Form	Number of Inserts	Part No.	
				$D_2   D_1$	K					A
i	25 - 14	15°	0.984	1.299	1.220	0.157	0.330 (lbs)	163	2	201087
	25 - 14	45°	0.787	1.299	1.220	0.255	0.330 (lbs)	112	2	201082
	32 - 18	15°	1.260	1.574	1.614	0.157	0.440 (lbs)	163	2	201088
	32 - 18	30°	0.984	1.614	1.614	0.314	0.440 (lbs)	163	2	201089
	32 - 18	45°	1.260	1.771	1.614	0.255	0.440 (lbs)	112	3	201083
m	25 - 14	15°	25.00	33.00	31.00	4.00	0.15 (kg)	163	2	201087
	25 - 14	45°	20.00	33.00	31.00	6.50	0.15 (kg)	112	2	201082
	32 - 18	15°	32.00	40.00	41.00	4.00	0.20 (kg)	163	2	201088
	32 - 18	30°	25.00	41.00	41.00	8.00	0.20 (kg)	163	2	201089
	32 - 18	45°	32.00	45.00	41.00	6.50	0.20 (kg)	112	3	201083

NOTE: K 45° for front and reverse side chamfering

NOTE: Inserts sold separately

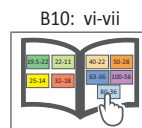
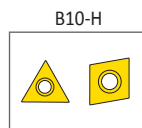
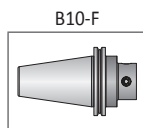
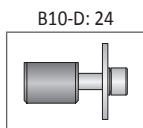
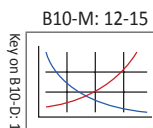

i = Imperial (in)  
m = Metric (mm)

Inserts sold separately

**IMPORTANT:** Max spindle speed refers to maximum possible speed for an individual boring head and is not a recommended parameter. Refer to page B10-M: 12 for recommended application-specific parameters. Factory technical assistance is available for your specific applications through our Application Engineering department.  
ext: 7611 | email: [appeng@alliedmachine.com](mailto:appeng@alliedmachine.com)

A  
B  
C  
D  
E  
F  
G  
H  
I  
J  
K  
L  
M  
INDEX

## Chamfering Tools

Imperial | Diameter Range: 0.748" - 2.795"

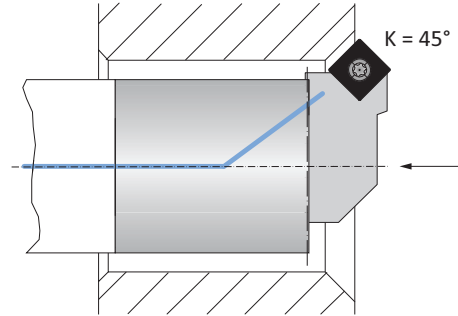
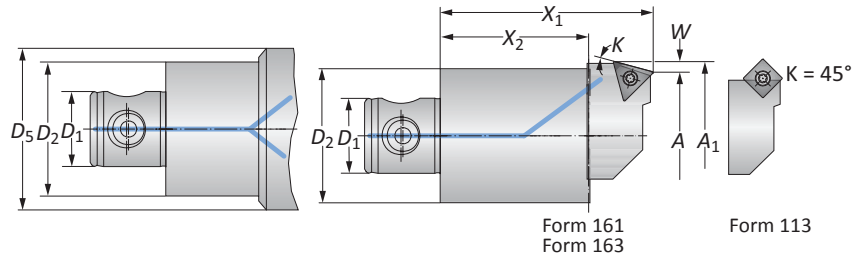

Connection	Approach Angle	Boring Range	Chamfering Range	Chamfering Tool				Weight (lbs)	Insert Form	Part No.	
				$D_2   D_1$	K	A	$A_1$			$X_1$	$X_2$
25 - 14	15°	0.945 - 1.260	1.141 - 1.457	2.362	1.653	-	0.098	0.440 (lbs)	161	201057	148001
25 - 14	15°	1.220 - 1.535	1.417 - 1.732	2.362	1.653	1.181	0.098	0.440 (lbs)	161	201058	148002
25 - 14	20°	0.866 - 1.181	1.141 - 1.456	2.362	1.653	-	0.138	0.440 (lbs)	161	201017	148001
25 - 14	20°	1.142 - 1.457	1.417 - 1.732	2.362	1.653	1.181	0.138	0.440 (lbs)	161	201018	148002
25 - 14	30°	0.787 - 1.102	1.141 - 1.456	2.362	1.653	-	0.177	0.440 (lbs)	161	201067	148001
25 - 14	30°	1.063 - 1.378	1.417 - 1.732	2.362	1.653	1.181	0.177	0.440 (lbs)	161	201068	148002
25 - 14	45°	0.748 - 1.063	1.141 - 1.456	2.283	1.653	-	0.197	0.440 (lbs)	161	201003*	148001
25 - 14	45°	1.024 - 1.339	1.417 - 1.732	2.283	1.653	-	0.197	0.440 (lbs)	161	201004*	148001
25 - 14	45°	1.220 - 1.535	1.692 - 2.007	2.362	1.653	1.181	0.236	0.440 (lbs)	112	201007	148002
32 - 18	15°	1.220 - 1.535	1.417 - 1.732	2.362	1.653	1.181	0.098	0.440 (lbs)	161	201058	148017
32 - 18	20°	1.142 - 1.457	1.417 - 1.732	2.362	1.653	1.181	0.138	0.440 (lbs)	161	201018	148017
32 - 18	30°	1.063 - 1.378	1.417 - 1.732	2.362	1.653	1.181	0.177	0.440 (lbs)	161	201068	148017
32 - 18	45°	1.220 - 1.535	1.692 - 2.007	2.362	1.653	1.181	0.236	0.440 (lbs)	112	201007	148017
32 - 18	15°	1.378 - 1.811	1.692 - 2.125	2.795	1.811	1.417	0.157	0.881 (lbs)	163	201059	148003
32 - 18	20°	1.299 - 1.732	1.692 - 2.125	2.795	1.811	1.417	0.197	0.881 (lbs)	163	201019	148003
32 - 18	30°	1.102 - 1.535	1.692 - 2.125	2.795	1.811	1.417	0.297	0.881 (lbs)	163	201069	148003
32 - 18	45°	1.378 - 1.811	1.968 - 2.401	2.598	1.811	1.417	0.295	0.881 (lbs)	113	201008	148003
40 - 22	15°	1.378 - 1.811	1.692 - 2.125	2.795	1.811	1.417	0.157	0.881 (lbs)	163	201059	148018
40 - 22	20°	1.299 - 1.732	1.692 - 2.125	2.795	1.811	1.417	0.197	0.881 (lbs)	163	201019	148018
40 - 22	30°	1.102 - 1.535	1.692 - 2.125	2.795	1.811	1.417	0.295	0.881 (lbs)	163	201069	148018
40 - 22	45°	1.378 - 1.811	1.968 - 2.401	2.598	1.811	1.417	0.295	0.881 (lbs)	113	201008	148018
40 - 22	15°	1.457 - 1.969	1.771 - 2.283	3.150	2.165	-	0.157	1.543 (lbs)	163	201060	148004
40 - 22	20°	1.457 - 1.969	1.850 - 2.362	3.150	2.165	-	0.197	1.543 (lbs)	163	201020	148004
40 - 22	30°	1.457 - 1.969	2.047 - 2.559	3.150	2.165	-	0.295	1.543 (lbs)	163	201070	148004
40 - 22	45°	1.963 - 2.205	2.283 - 2.795	3.150	2.165	-	0.295	1.543 (lbs)	113	201009	148004

\*Insert holder cannot be used for reverse machining.  
**NOTE:** K 45° for front and reverse side chamfering above  $\varnothing 1.220"$   
**NOTE:** Insert holders and inserts sold separately

Key on B10-D-1

B10-M: 12-15

B10-D: 24

B10-F

B10-H

B10: vi-vii

**i** = Imperial (in)  
**m** = Metric (mm)

Inserts sold separately

**IMPORTANT:** Max spindle speed refers to maximum possible speed for an individual boring head and is not a recommended parameter. Refer to page B10-M: 12 for recommended application-specific parameters. Factory technical assistance is available for your specific applications through our Application Engineering department.  
 ext: 7611 | email: [appeng@alliedmachine.com](mailto:appeng@alliedmachine.com)

## Chamfering Tools

Metric | Diameter Range: (19.00 mm - 71.00 mm)

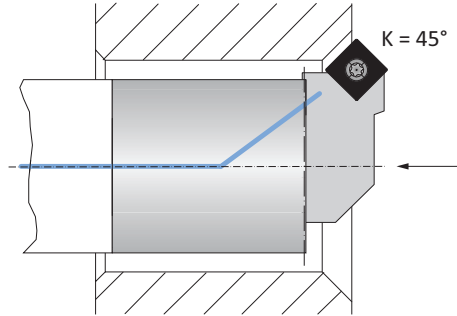
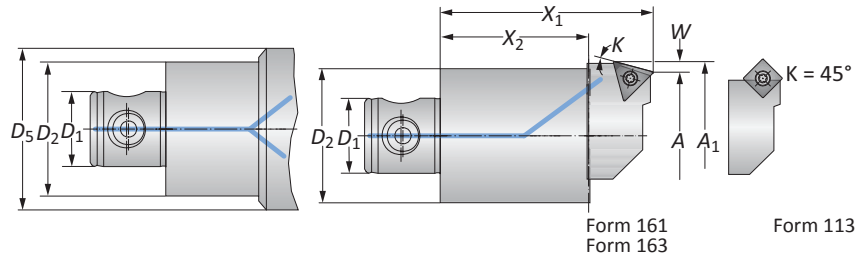

Connection	Approach Angle	Boring Range	Chamfering Range	Chamfering Tool				Weight (lbs)	Insert Form	Part No.		
				$D_2   D_1$	K	A	$A_1$			$X_1$	$X_2$	$D_5$
m	25 - 14	15°	24.00 - 32.00	29.00 - 37.00	60.00	42.00	-	2.50	0.20 (kg)	161	201057	148001
	25 - 14	15°	31.00 - 39.00	36.00 - 44.00	60.00	42.00	30.00	2.50	0.20 (kg)	161	201058	148002
	25 - 14	20°	22.00 - 30.00	29.00 - 37.00	60.00	42.00	-	3.50	0.20 (kg)	161	201017	148001
	25 - 14	20°	29.00 - 37.00	36.00 - 44.00	60.00	42.00	30.00	3.50	0.20 (kg)	161	201018	148002
	25 - 14	30°	20.00 - 28.00	29.00 - 37.00	60.00	42.00	-	4.50	0.20 (kg)	161	201067	148001
	25 - 14	30°	27.00 - 35.00	36.00 - 44.00	60.00	42.00	30.00	4.50	0.20 (kg)	161	201068	148002
	25 - 14	45°	19.00 - 27.00	29.00 - 37.00	58.00	42.00	-	5.00	0.20 (kg)	161	201003*	148001
	25 - 14	45°	26.00 - 34.00	36.00 - 44.00	58.00	42.00	-	5.00	0.20 (kg)	161	201004*	148001
	25 - 14	45°	31.00 - 39.00	43.00 - 51.00	60.00	42.00	30.00	6.00	0.20 (kg)	112	201007	148002
	32 - 18	15°	31.00 - 39.00	36.00 - 44.00	60.00	42.00	30.00	2.50	0.20 (kg)	161	201058	148017
	32 - 18	20°	29.00 - 37.00	36.00 - 44.00	60.00	42.00	30.00	3.50	0.20 (kg)	161	201018	148017
	32 - 18	30°	27.00 - 35.00	36.00 - 44.00	60.00	42.00	30.00	4.50	0.20 (kg)	161	201068	148017
	32 - 18	45°	31.00 - 39.00	43.00 - 51.00	60.00	42.00	30.00	6.00	0.20 (kg)	112	201077	148017
	32 - 18	15°	35.00 - 46.00	43.00 - 54.00	71.00	46.00	36.00	4.00	0.40 (kg)	163	201059	148003
	32 - 18	20°	33.00 - 44.00	43.00 - 54.00	71.00	46.00	36.00	5.00	0.40 (kg)	163	201019	148003
	32 - 18	30°	28.00 - 39.00	43.00 - 54.00	71.00	46.00	36.00	7.50	0.40 (kg)	163	201069	148003
	32 - 18	45°	35.00 - 46.00	50.00 - 61.00	66.00	46.00	36.00	7.50	0.40 (kg)	113	201008	148003
	40 - 22	15°	35.00 - 46.00	43.00 - 54.00	71.00	46.00	36.00	4.00	0.40 (kg)	163	201059	148018
	40 - 22	20°	33.00 - 44.00	43.00 - 54.00	71.00	46.00	36.00	5.00	0.40 (kg)	163	201019	148018
	40 - 22	30°	28.00 - 39.00	43.00 - 54.00	71.00	46.00	36.00	7.50	0.40 (kg)	163	201069	148018
40 - 22	45°	35.00 - 46.00	50.00 - 61.00	66.00	46.00	36.00	7.50	0.40 (kg)	113	201008	148018	
40 - 22	15°	37.00 - 50.00	45.00 - 58.00	80.00	55.00	-	4.00	0.70 (kg)	163	201060	148004	
40 - 22	20°	37.00 - 50.00	47.00 - 60.00	80.00	55.00	-	5.00	0.70 (kg)	163	201020	148004	
40 - 22	30°	37.00 - 50.00	52.00 - 65.00	80.00	55.00	-	7.50	0.70 (kg)	163	201070	148004	
40 - 22	45°	43.00 - 56.00	58.00 - 71.00	80.00	55.00	-	7.50	0.70 (kg)	113	201009	148004	

\*Insert holder cannot be used for reverse machining.

NOTE: K 45° for front and reverse side chamfering above  $\varnothing$  31.00 mm

NOTE: Insert holders and inserts sold separately

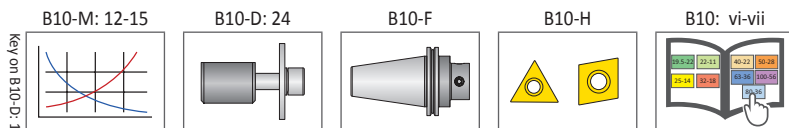

**i** = Imperial (in)  
**m** = Metric (mm)

Inserts sold separately

**IMPORTANT:** Max spindle speed refers to maximum possible speed for an individual boring head and is not a recommended parameter. Refer to page B10-M: 12 for recommended application-specific parameters. Factory technical assistance is available for your specific applications through our Application Engineering department.  
ext: 7611 | email: [appeng@alliedmachine.com](mailto:appeng@alliedmachine.com)

## Chamfering Tools

Diameter Range: 1.969" - 8.504" (50.00 mm - 216.00 mm)

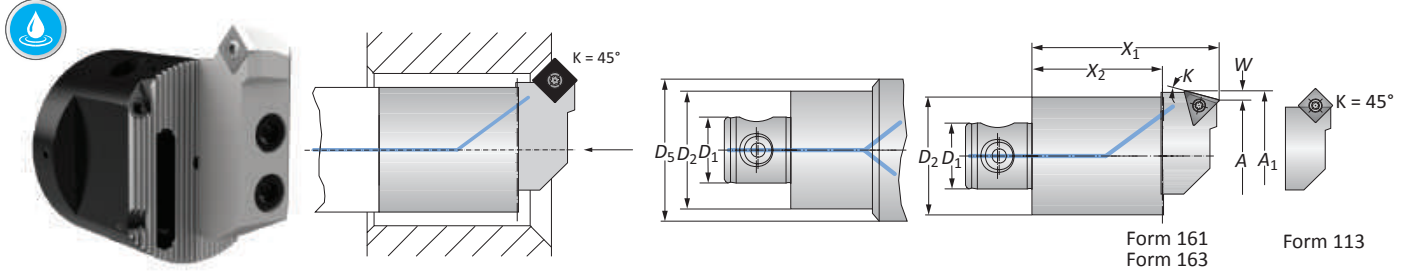

Connection	Approach Angle	Boring Range	Chamfering Range	Chamfering Tool				Weight	Insert Form	Part No.	
				$D_2$   $D_1$	K	A	$A_1$			$X_1$	$X_2$
50 - 28	15°	1.969 - 2.677	2.283 - 2.992	3.150	2.165	-	0.157	2.204 (lbs)	163	201061	148005
50 - 28	20°	1.969 - 2.677	2.362 - 3.070	3.150	2.165	-	0.197	2.204 (lbs)	163	201021	148005
50 - 28	30°	1.969 - 2.677	2.559 - 3.267	3.150	2.165	-	0.197	2.204 (lbs)	163	201071	148005
50 - 28	45°	2.165 - 2.874	2.755 - 3.464	3.150	2.165	-	0.295	2.204 (lbs)	113	201010	148005
63 - 36	15°	2.677 - 3.504	2.992 - 3.818	3.543	2.362	-	0.157	4.188 (lbs)	163	201062	148006
63 - 36	20°	2.677 - 3.504	3.070 - 3.897	3.543	2.362	-	0.197	4.188 (lbs)	163	201022	148006
63 - 36	30°	2.677 - 3.504	3.268 - 4.094	3.543	2.362	-	0.295	4.188 (lbs)	163	201072	148006
63 - 36	45°	2.835 - 3.661	3.425 - 4.251	3.543	2.362	-	0.295	4.188 (lbs)	113	201011	148006
80 - 36	15°	3.504 - 4.685	3.818 - 5.000	3.543	2.362	-	0.157	5.732 (lbs)	163	201063	148007
80 - 36	15°	4.685 - 5.866	5.000 - 6.259	3.543	2.362	-	0.157	5.952 (lbs)	163	201064	148007
80 - 36	15°	5.669 - 7.835	5.984 - 8.149	3.543	2.362	4.921	0.157	7.936 (lbs)	163	201064	148009
80 - 36	20°	3.504 - 4.685	3.989 - 5.078	3.543	2.362	-	0.197	5.732 (lbs)	163	201023	148007
80 - 36	20°	4.685 - 5.866	5.078 - 6.259	3.543	2.362	-	0.197	5.952 (lbs)	163	201024	148007
80 - 36	20°	5.669 - 7.835	6.062 - 8.228	3.543	2.362	4.921	0.197	7.936 (lbs)	163	201024	148009
80 - 36	30°	3.504 - 4.685	4.094 - 5.275	3.543	2.362	-	0.295	5.732 (lbs)	163	201073	148007
80 - 36	30°	4.685 - 5.866	5.275 - 6.456	3.543	2.362	-	0.295	5.952 (lbs)	163	201074	148007
80 - 36	30°	5.669 - 7.835	6.259 - 8.425	3.543	2.362	4.921	0.295	7.936 (lbs)	163	201074	148009
80 - 36	45°	3.622 - 4.803	4.212 - 5.393	3.543	2.362	-	0.295	5.732 (lbs)	113	201012	148007
80 - 36	45°	4.764 - 5.945	5.354 - 6.535	3.543	2.362	-	0.295	5.952 (lbs)	113	201013	148007
80 - 36	45°	5.748 - 7.913	6.338 - 8.504	3.543	2.362	4.921	0.295	7.936 (lbs)	113	201013	148009
50 - 28	15°	50.00 - 68.00	58.00 - 76.00	80.00	55.00	-	4.00	1.00 (kg)	163	201061	148005
50 - 28	20°	50.00 - 68.00	60.00 - 78.00	80.00	55.00	-	5.00	1.00 (kg)	163	201021	148005
50 - 28	30°	50.00 - 68.00	65.00 - 83.00	80.00	55.00	-	7.50	1.00 (kg)	163	201071	148005
50 - 28	45°	55.00 - 73.00	70.00 - 88.00	80.00	55.00	-	7.50	1.00 (kg)	113	201010	148005
63 - 36	15°	68.00 - 89.00	76.00 - 97.00	90.00	60.00	-	4.00	1.90 (kg)	163	201062	148006
63 - 36	20°	68.00 - 89.00	78.00 - 99.00	90.00	60.00	-	5.00	1.90 (kg)	163	201022	148006
63 - 36	30°	68.00 - 89.00	83.00 - 104.00	90.00	60.00	-	7.50	1.90 (kg)	163	201072	148006
63 - 36	45°	72.00 - 93.00	87.00 - 108.00	90.00	60.00	-	7.50	1.90 (kg)	113	201011	148006
80 - 36	15°	89.00 - 119.00	97.00 - 127.00	90.00	60.00	-	4.00	2.60 (kg)	163	201063	148007
80 - 36	15°	119.00 - 149.00	127.00 - 159.00	90.00	60.00	-	4.00	2.70 (kg)	163	201064	148007
80 - 36	15°	144.00 - 199.00	152.00 - 207.00	90.00	60.00	125.00	4.00	3.60 (kg)	163	201064	148009
80 - 36	20°	89.00 - 119.00	99.00 - 129.00	90.00	60.00	-	5.00	2.60 (kg)	163	201023	148007
80 - 36	20°	119.00 - 149.00	129.00 - 159.00	90.00	60.00	-	5.00	2.70 (kg)	163	201024	148007
80 - 36	20°	144.00 - 199.00	154.00 - 209.00	90.00	60.00	125.00	5.00	3.60 (kg)	163	201024	148009
80 - 36	30°	89.00 - 119.00	104.00 - 134.00	90.00	60.00	-	7.50	2.60 (kg)	163	201073	148007
80 - 36	30°	119.00 - 149.00	134.00 - 164.00	90.00	60.00	-	7.50	2.70 (kg)	163	201074	148007
80 - 36	30°	144.00 - 199.00	159.00 - 214.00	90.00	60.00	125.00	7.50	3.60 (kg)	163	201074	148009
80 - 36	45°	92.00 - 122.00	107.00 - 137.00	90.00	60.00	-	7.50	2.60 (kg)	113	201012	148007
80 - 36	45°	121.00 - 151.00	136.00 - 166.00	90.00	60.00	-	7.50	2.70 (kg)	113	201013	148007
80 - 36	45°	146.00 - 201.00	161.00 - 216.00	90.00	60.00	125.00	7.50	3.60 (kg)	113	201013	148009

NOTE: K 45° = front and reverse side chamfering  
 NOTE: Insert holders and inserts sold separately

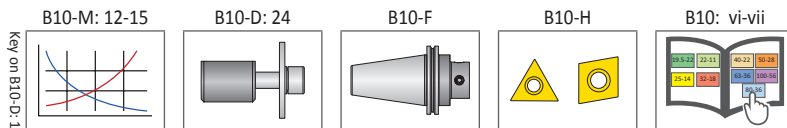

ⓘ = Imperial (in)  
 ⓘ = Metric (mm)  
 Inserts sold separately

**IMPORTANT:** Max spindle speed refers to maximum possible speed for an individual boring head and is not a recommended parameter. Refer to page B10-M: 12 for recommended application-specific parameters. Factory technical assistance is available for your specific applications through our Application Engineering department.  
 ext: 7611 | email: [appeng@alliedmachine.com](mailto:appeng@alliedmachine.com)

### Grooving Tools for Circular Milling

Diameter Range:  $\varnothing > 0.787''$  (20.00 mm)

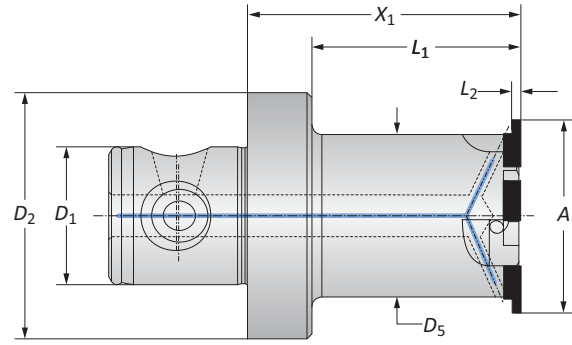
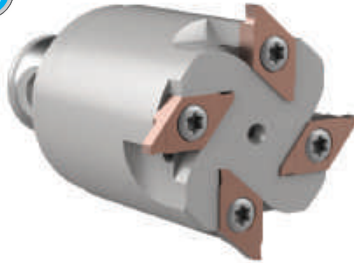

Connection	Cutter Diameter	Grooving Tool			Groove Width	Groove Depth	Number of Inserts	Weight	Insert Form	Part No.	
		$D_2   D_1$	A	$X_1$							$L_1$
i	50 - 28	0.787	2.165	1.575	0.669	max 0.093	max 0.059	2	0.881 (lbs)	89	143051
	50 - 28	0.787	3.740	3.228	0.669	max 0.093	max 0.059	2	0.881 (lbs)	89	143052
	50 - 28	1.535	2.165	1.654	1.299	max 0.133	max 0.098	4	1.322 (lbs)	90	143053
	32 - 18	1.535	1.575	1.575	1.299	max 0.133	max 0.098	4	0.661 (lbs)	90	143054
	50 - 28	1.929	2.165	1.575	1.692	max 0.133	max 0.098	5	1.543 (lbs)	90	143055
	40 - 22	1.929	1.575	1.575	1.692	max 0.133	max 0.098	5	1.102 (lbs)	90	143056
	50 - 28	2.480	1.575	1.575	2.086	max 0.231	max 0.185	6	1.543 (lbs)	91	143057
	63 - 36	3.110	1.575	1.575	2.716	max 0.231	max 0.185	8	2.645 (lbs)	91	143058
ii	50 - 28	20.00	55.00	40.00	17.00	max 2.37	max 1.50	2	0.40 (kg)	89	143051
	50 - 28	20.00	95.00	82.00	17.00	max 2.37	max 1.50	2	0.40 (kg)	89	143052
	50 - 28	39.00	55.00	42.00	33.00	max 3.37	max 2.50	4	0.60 (kg)	90	143053
	32 - 18	39.00	40.00	40.00	33.00	max 3.37	max 2.50	4	0.30 (kg)	90	143054
	50 - 28	49.00	55.00	40.00	43.00	max 3.37	max 2.50	5	0.70 (kg)	90	143055
	40 - 22	49.00	40.00	40.00	43.00	max 3.37	max 2.50	5	0.50 (kg)	90	143056
	50 - 28	63.00	40.00	40.00	53.00	max 5.87	max 4.70	6	0.70 (kg)	91	143057
	63 - 36	79.00	40.00	40.00	69.00	max 5.87	max 4.70	8	1.20 (kg)	91	143058

NOTE: Different lengths available upon request.  
 NOTE: Insert holders and inserts sold separately

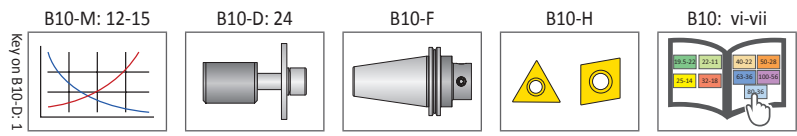

i = Imperial (in)  
 ii = Metric (mm)  
 Inserts sold separately

**IMPORTANT:** Max spindle speed refers to maximum possible speed for an individual boring head and is not a recommended parameter. Refer to page B10-M: 12 for recommended application-specific parameters. Factory technical assistance is available for your specific applications through our Application Engineering department.  
 ext: 7611 | email: [appeng@alliedmachine.com](mailto:appeng@alliedmachine.com)

A  
B  
C  
D  
E  
F  
G  
H  
I  
J  
K  
L  
M  
INDEX

## Axial Grooving Tools

Diameter Range: 0.787" - 8.071" (20.00 mm - 205.00 mm)

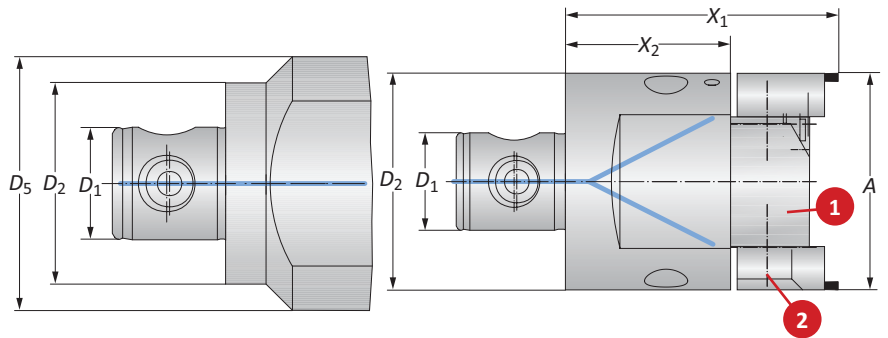

	Connection	Boring Range	Grooving Tool			Weight	Part No.			
			$D_2   D_1$	A	$X_1$		$X_2$	$D_5$	1. Support Block	Insert Form
i	50 - 28	0.787 - 2.283	3.268	2.165	2.480	2.866 (lbs)	–	304	226030	148010
	80 - 36	2.244 - 3.307	3.937	2.362	–	5.732 (lbs)	226011	304	226031	148007
	80 - 36	3.228 - 6.102	3.937	2.362	4.921	8.157 (lbs)	226012	304	226031	148009
	80 - 36	6.024 - 8.071	3.937	2.362	4.921	8.157 (lbs)	226013	304	226031	148009
m	50 - 28	20.00 - 58.00	83.00	55.00	63.00	1.30 (kg)	–	304	226030	148010
	80 - 36	57.00 - 84.00	100.00	60.00	–	2.60 (kg)	226011	304	226031	148007
	80 - 36	82.00 - 155.00	100.00	60.00	125.00	3.70 (kg)	226012	304	226031	148009
	80 - 36	153.00 - 205.00	100.00	60.00	125.00	3.70 (kg)	226013	304	226031	148009

**NOTE:** Groove width is 0.039" - 0.276" (1.00 mm - 7.00 mm). (With Twin Cutter and diameter offset up to 12.00 mm is possible.) | Groove depth is 0.039" - 0.236" (1.00 mm - 6.00 mm)

**NOTE:** Support block with machining diameters smaller than 4.842" (123.00 mm) can only be secured with one screw

**NOTE:** Insert holders, support blocks, and inserts sold separately

### Examples of recessing replaceable inserts:

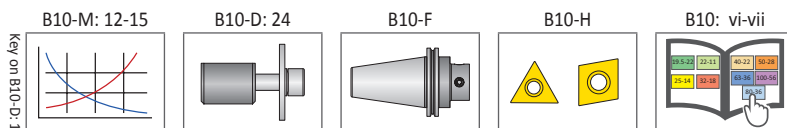
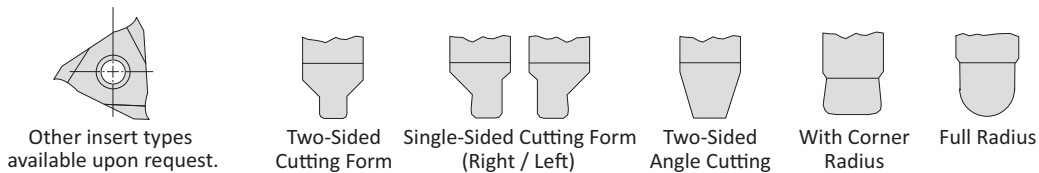

i = Imperial (in)  
m = Metric (mm)

Inserts sold separately

**IMPORTANT:** Max spindle speed refers to maximum possible speed for an individual boring head and is not a recommended parameter. Refer to page B10-M: 12 for recommended application-specific parameters. Factory technical assistance is available for your specific applications through our Application Engineering department.  
ext: 7611 | email: [appeng@alliedmachine.com](mailto:appeng@alliedmachine.com)



## Reverse Machining Tools

Diameter Range: 1.142" - 9.646" (29.00 mm - 245.00 mm)

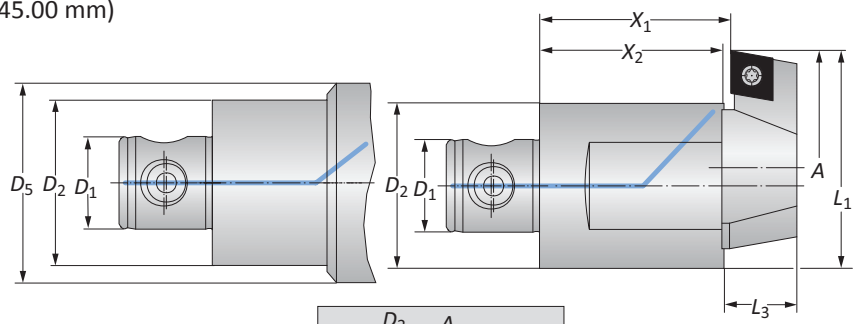
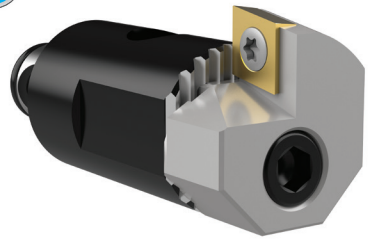

$$L_1 = \frac{D_2}{2} + \frac{A}{2} + 0.5 \text{ mm}$$

Connection	Boring Range	Reverse Machining					Weight	Insert Form	Insert Holder	Part No.
		D <sub>2</sub>   D <sub>1</sub>	A	X <sub>1</sub>	X <sub>2</sub>	L <sub>3</sub>				D <sub>5</sub>
i	25 - 14	1.142 - 1.457	1.575	1.535	0.551	-	0.440 (lbs)	103	251001	148011
	25 - 14	1.339 - 1.654	1.575	1.535	0.551	-	0.440 (lbs)	103	251002	148011
	25 - 14	1.417 - 1.732	1.575	1.535	0.551	-	0.440 (lbs)	103	251002	148012
	25 - 14	1.732 - 2.047	1.575	1.535	0.708	-	0.440 (lbs)	104	251003	148012
	32 - 18	1.693 - 2.126	1.575	1.535	0.708	-	0.661 (lbs)	104	251003	148013
	32 - 18	2.165 - 2.598	1.575	1.535	0.708	-	0.881 (lbs)	104	251004	148013
	40 - 22	2.087 - 2.835	1.575	1.535	0.708	-	1.102 (lbs)	104	251004	148014
	40 - 22	2.598 - 3.346	1.575	1.535	0.708	-	1.102 (lbs)	104	251005	148014
	50 - 28	2.756 - 3.740	2.205	2.165	0.866	-	2.425 (lbs)	104	251006	148015
	50 - 28	3.622 - 4.606	2.205	2.165	0.866	-	2.866 (lbs)	104	251007	148015
	63 - 36	3.622 - 4.803	2.205	2.165	0.866	-	3.747 (lbs)	104	251007	148016
	80 - 36	4.724 - 5.906	2.441	2.362	1.023	-	5.952 (lbs)	104	251008	148007
80 - 36	6.535 - 7.717	2.441	2.362	1.023	-	6.393 (lbs)	104	251009	148007	
80 - 36	5.709 - 7.874	2.441	2.362	1.023	4.921	7.936 (lbs)	104	251008	148009	
80 - 36	7.480 - 9.646	2.441	2.362	1.023	4.921	8.157 (lbs)	104	251009	148009	
m	25 - 14	29.00 - 37.00	40.00	39.00	14.00	-	0.20 (kg)	103	251001	148011
	25 - 14	34.00 - 42.00	40.00	39.00	14.00	-	0.20 (kg)	103	251002	148011
	25 - 14	36.00 - 44.00	40.00	39.00	14.00	-	0.20 (kg)	103	251002	148012
	25 - 14	44.00 - 52.00	40.00	39.00	18.00	-	0.20 (kg)	104	251003	148012
	32 - 18	43.00 - 54.00	40.00	39.00	18.00	-	0.30 (kg)	104	251003	148013
	32 - 18	55.00 - 66.00	40.00	39.00	18.00	-	0.40 (kg)	104	251004	148013
	40 - 22	53.00 - 72.00	40.00	39.00	18.00	-	0.50 (kg)	104	251004	148014
	40 - 22	66.00 - 85.00	40.00	39.00	18.00	-	0.50 (kg)	104	251005	148014
	50 - 28	70.00 - 95.00	56.00	55.00	22.00	-	1.10 (kg)	104	251006	148015
	50 - 28	92.00 - 117.00	56.00	55.00	22.00	-	1.30 (kg)	104	251007	148015
	63 - 36	92.00 - 122.00	56.00	55.00	22.00	-	1.70 (kg)	104	251007	148016
	80 - 36	120.00 - 150.00	62.00	60.00	26.00	-	2.70 (kg)	104	251008	148007
80 - 36	166.00 - 196.00	62.00	60.00	26.00	-	2.90 (kg)	104	251009	148007	
80 - 36	145.00 - 200.00	62.00	60.00	26.00	125.00	3.60 (kg)	104	251008	148009	
80 - 36	190.00 - 245.00	62.00	60.00	26.00	125.00	3.70 (kg)	104	251009	148009	

**NOTE:** Only use inserts with chip grooves all around  
**NOTE:** Insert holders and inserts sold separately

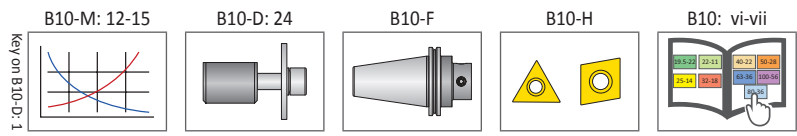

i = Imperial (in)  
 m = Metric (mm)  
 Inserts sold separately

**IMPORTANT:** Max spindle speed refers to maximum possible speed for an individual boring head and is not a recommended parameter. Refer to page B10-M: 12 for recommended application-specific parameters. Factory technical assistance is available for your specific applications through our Application Engineering department.  
 ext: 7611 | email: [appeng@alliedmachine.com](mailto:appeng@alliedmachine.com)

## VolCut Insert Holders

Diameter Range: 2.559" - 128.150" (65.00 mm - 3255.00 mm)

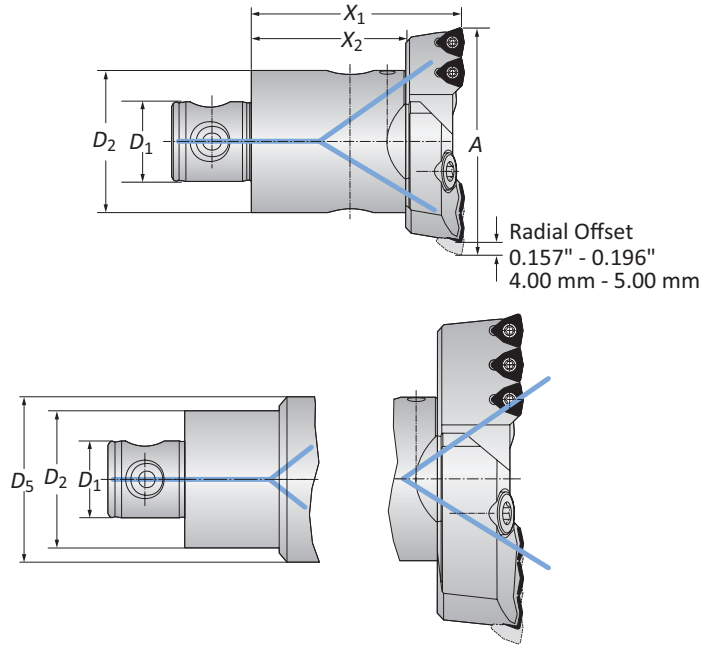

### Serrated Bodies with VolCut Insert Holders



Connection	Boring Range		Serrated Body			Weight	Number of Inserts	Insert Form	Part No.		
	D <sub>2</sub>   D <sub>1</sub>	A	A <sub>min</sub> **	X <sub>1</sub>	X <sub>2</sub>				D <sub>5</sub>	VolCut Insert Holder	Serrated Body
i	50 - 28	2.559 - 3.268	2.559 - 2.756	2.913	2.165	-	2.425 (lbs)	2	464	151019	148005
	63 - 36	3.228 - 4.055	3.228 - 3.425	3.504	2.362	-	4.850 (lbs)	3	464	151039	148006
	80 - 36	3.937 - 5.118	3.937 - 4.134	3.504	2.362	-	6.613 (lbs)	3	464	151059	148007
	80 - 36	4.921 - 6.102	4.921 - 5.118	3.504	2.362	-	7.054 (lbs)	3	464	151069	148007
	80 - 36	5.906 - 8.071	5.906 - 6.102	3.504	2.362	4.921	11.243 (lbs)	3	464	151069	148009
⚠ D60	7.874 - 128.150	-	-	-	-	-	-	3	464	149030	*
m	50 - 28	65.00 - 83.00	65.00 - 70.00	74.00	55.00	-	1.10 (kg)	2	464	151019	148005
	63 - 36	82.00 - 103.00	82.00 - 87.00	89.00	60.00	-	2.20 (kg)	3	464	151039	148006
	80 - 36	100.00 - 130.00	100.00 - 105.00	89.00	60.00	-	3.00 (kg)	3	464	151059	148007
	80 - 36	125.00 - 155.00	125.00 - 130.00	89.00	60.00	-	3.20 (kg)	3	464	151069	148007
	80 - 36	150.00 - 205.00	150.00 - 155.00	89.00	60.00	125.00	5.10 (kg)	3	464	151069	148009
⚠ D60	200.00 - 3255.00	-	-	-	-	-	-	3	464	149030	*

NOTE: Inserts, insert holders, and serrated body are sold separately.

\*For large diameter serrated slides, please contact Application Eng. (330.343.4283 ext: 7611) and see section B10-G in the Wohlhaupter® MultiBore® System Tools catalog.

\*\*For smaller diameters, both cartridges must be set to the same diameter. Only the outside insert on each cartridge can be engaged in the material.

### IC Inserts

Carbide Grade	Geometry	Part No.	WSP-Screw
			
		AM300®	
P35 (C5)	Standard	OP-05T308-P	IS-10-1
K35 (C1)	Standard	OP-05T308-1P	IS-10-1
K20 (C2)	Standard	OP-05T308-2P	IS-10-1
P35 (C5)	High Rake	OP-05T308-PHR	IS-10-1

NOTE: See section A70 in the Allied Master Product Catalog for recommended cutting data, cutting materials, and geometries.

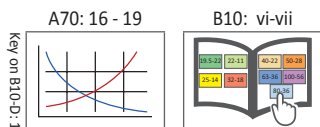

i = Imperial (in)  
m = Metric (mm)

**WARNING** For large diameter boring with VolCut insert holders please:  
- Contact our Application Engineering department before purchasing (330.343.4283 ext: 7611 | email: [appeng@alliedmachine.com](mailto:appeng@alliedmachine.com))  
- Refer to section B10-G in the Wohlhaupter® MultiBore® System Tools catalog.

## VolCut Technical Information

### Setup Instructions | Minimum Pilot Calculation



**Step 1:**  
Loosen the mounting screws on both cartridges.



**Step 2:**  
Set one cartridge to the finish diameter by tightening the adjustment screw against the adjustment pin.



**Step 3:**  
Tighten the mounting screws on the cartridge to 15-19 Nm (11-14 ft-lbf).

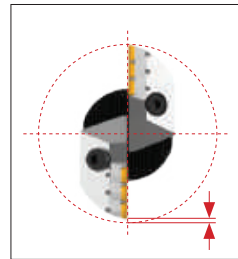

**Step 4:**  
Set the opposing cartridge with 0.157" - 0.196" (4 mm - 5 mm) radial offset inward by tightening the adjustment screw against the adjustment pin (optimum situation for each insert to remove equal material).



**Step 5:**  
Tighten the mounting screws on the cartridge to 15-19 Nm (11-14 ft-lbf).

**Note:** Drilling systems with OP inserts are used as single cutters. The replaceable inserts are mounted offset in diameter. Please review the assembly instructions.

#### Minimum Pilot Calculation

Calculation: Finish Diameter - Opening Range = Minimum Pilot Hole Diameter

Insert Holder	Diameter Range	Opening Range
151019	2.559" - 2.756" (65.00 mm - 70.00 mm)	0.600" (15.24 mm)
	2.756" - 3.268" (70.00 mm - 83.00 mm)	1.880" (47.75 mm)
151039	3.228" - 3.425" (82.00 mm - 87.00 mm)	0.600" (15.24 mm)
	3.425" - 4.055" (87.00 mm - 103.00 mm)	2.680" (68.07 mm)
151059	3.937" - 4.134" (100.00 mm - 105.00 mm)	0.600" (15.24 mm)
	4.134" - 5.118" (105.00 mm - 130.00 mm)	2.680" (68.07 mm)
151069	4.921" - 5.118" (125.00 mm - 130.00 mm)	0.600" (15.24 mm)
	5.118" - 8.071" (130.00 mm - 205.00 mm)	2.680" (68.07 mm)
149030	7.874" - 128.150" (200.00 mm - 3255.00 mm)	2.680" (68.07 mm)

**Example:** To open an existing hole to 4.500" diameter, a 151059 insert holder would be used with a 148007 serrated tool body, and the minimum pilot diameter would be 4.500" - 2.680" = 1.820".

A  
B  
C  
D  
E  
F  
G  
H  
I  
J  
K  
L  
M  
INDEX

## Accessories

### Clamping Elements | Axial Grooving Accessories

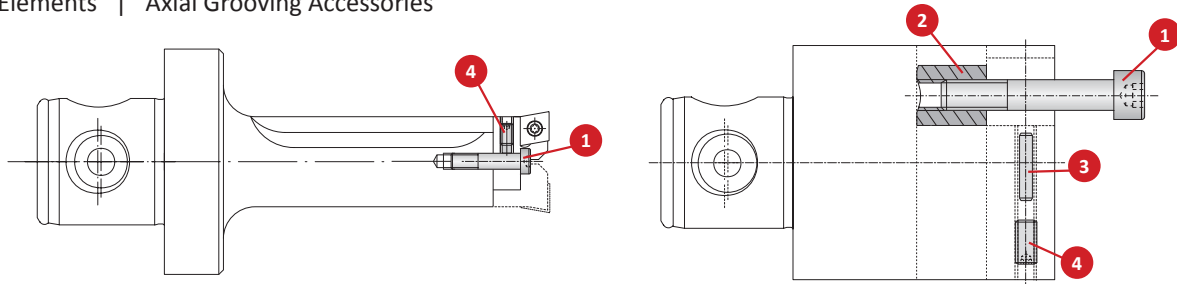

#### Clamping Elements

Connection	Serrated Tool Body	Part No.					
		1. Cap Screw	Service Key	2. Clamping Nut	3. Adjustment Pin	4. Thread Pin	Service Key
25 - 14	148001	140108	s4 / B	140114	-	115280	s2.5 / A
25 - 14	148002	148110	s5 / B	115667	-	126157	s2.5 / A
25 - 14	148011	148110	s5 / B	148113	-	117148	s2.5 / A
25 - 14	148012	148110	s5 / B	115666	-	117148	s2.5 / A
32 - 18	148003	140110	s5 / B	115667	-	126157	s2.5 / A
32 - 18	148013	148110	s5 / B	148114	-	115192	s2.5 / A
32 - 18	148017	148110	s5 / B	115667	-	126157	s2.5 / A
40 - 22	148004	140110	s5 / B	140116	-	115407	s2.5 / A
40 - 22	148014	148110	s5 / B	148114	-	126157	s2.5 / A
40 - 22	148018	140110	s5 / B	115667	-	126157	s2.5 / A
50 - 28	148005	140111	s6 / B	140117	-	140121	s2.5 / A
50 - 28	148010	140111	s6 / B	140117	-	140121	s2.5 / A
50 - 28	148015	140112	s6 / B	140117	-	215111	s2.5 / A
50 - 28	235001	415111	T25 / B	-	-	215346	s1.5 / A
50 - 28	235002	415112	T25 / B	-	-	215346	s1.5 / A
50 - 28	235003	415113	T25 / B	-	-	215346	s1.5 / A
50 - 28	148021	140108	s4 / B	140114	-	115280	s2.5 / A
50 - 28	148022	140110	s5 / B	115667	-	126157	s2.5 / A
50 - 28	148023	140110	s5 / B	115667	-	126157	s2.5 / A
50 - 28	148024	140110	s5 / B	140116	-	115407	s2.5 / A
63 - 36	148006	140112	s6 / B	140118	-	140121	s2.5 / A
63 - 36	148016	140112	s6 / B	140117	-	116550	s2.5 / A
63 - 36	235011	415111	T25 / B	-	-	215346	s1.5 / A
63 - 36	235012	415112	T25 / B	-	-	215346	s1.5 / A
63 - 36	235013	415113	T25 / B	-	-	215346	s1.5 / A
80 - 36	148007	115730	s6 / B	140119	-	116550	s2.5 / A
80 - 36	148009	115730	s6 / B	140119	140120	115519	s2.5 / A
∅ 18	235021	415111	T25 / B	-	-	215346	s1.5 / A
∅ 20	235022	415112	T25 / B	-	-	215346	s1.5 / A
∅ 23	235023	415113	T25 / B	-	-	215346	s1.5 / A

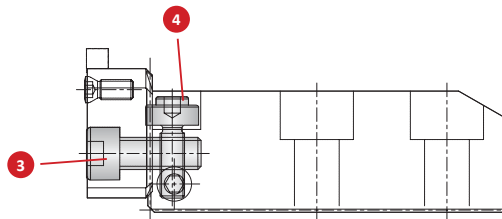

#### Axial Grooving Accessories

Support Base	3. Cap Screw		4. Axial Adjustment Screw	
	Part No.	Service Key	Part No.	Service Key
226011	023182	s6 / B	215374	s4 / B
226012	023182	s6 / B	215374	s4 / B
226013	023182	s6 / B	215374	s4 / B

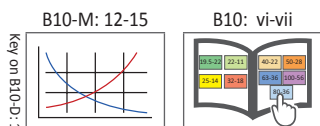

i = Imperial (in)  
m = Metric (mm)



# Guaranteed Test / Demo Application Form

Distributor PO # \_\_\_\_\_

The following must be filled out completely before your test will be considered

**IMPORTANT:** For processing, send Purchase Order to your Allied Field Sales Engineer (FSE). Please clearly mark the paperwork as "Test Order."

## Distributor Information

Company Name: \_\_\_\_\_  
 Contact: \_\_\_\_\_  
 Account Number: \_\_\_\_\_  
 Phone: \_\_\_\_\_  
 Email: \_\_\_\_\_

## End User Information

Company Name: \_\_\_\_\_  
 Contact: \_\_\_\_\_  
 Industry: \_\_\_\_\_  
 Phone: \_\_\_\_\_  
 Email: \_\_\_\_\_

**Current Process** List all tooling, coatings, substrates, speeds and feeds, tool life, and any problems you are experiencing

\_\_\_\_\_

\_\_\_\_\_

**Test Objective** List what would make this a successful test (i.e. penetration rate, finish, tool life, hole size, etc.)

\_\_\_\_\_

\_\_\_\_\_

## Application Information

Hole Diameter: _____ in/mm	Tolerance: _____	Material: _____ (4150 / A36 / Cast Iron / etc.)
Preexisting Diameter: _____ in/mm	Depth of Cut: _____ in/mm	Hardness: _____ (BHN / Rc)
Required Finish: _____ RMS	State: _____	(Casting / Hot rolled / Forging)

## Machine Information

Machine Type: _____ (Lathe / Screw machine / Machine center / etc.)	Builder: _____ (Haas, Mori Seiki, etc.)	Model #: _____
Shank Required: _____ (CAT50 / Morse taper, etc.)		Power: _____ HP/KW
Rigidity: _____	Orientation: _____	Tool Rotating: _____
<input type="checkbox"/> Excellent	<input type="checkbox"/> Vertical	<input type="checkbox"/> Yes
<input type="checkbox"/> Good	<input type="checkbox"/> Horizontal	<input type="checkbox"/> No
<input type="checkbox"/> Poor		Thrust: _____ lbs/N

## Coolant Information

Coolant Delivery: _____ (Through tool / Flood)	Coolant Pressure: _____ PSI / bar
Coolant Type: _____ (Air mist, oil, synthetic, water soluble, etc.)	Coolant Volume: _____ GPM / LPM

## Requested Tooling

QTY	Item Number

QTY	Item Number



**Allied Machine & Engineering**  
 120 Deeds Drive  
 Dover, OH 44622

Telephone: (330) 343-4283  
 Toll Free USA & Canada: (800) 321-5537  
 Fax: (330) 602-3400  
 Email: info@alliedmachine.com

## Warranty Information



Allied Machine & Engineering ("Allied Machine") warrants to original equipment manufacturers, distributors, industrial and commercial users of its products for one year from the original date of sale that each new product manufactured or supplied by Allied Machine shall be free from defects in material and workmanship.

Allied Machine's sole and exclusive obligation under this warranty is limited to, at its option, without additional charge, replacing or repairing this product or issuing a credit. For this warranty to be applied, the product must be returned freight prepaid to the plant designated by an Allied Machine representative and which, upon inspection, is determined by Allied Machine to be defective in material and workmanship.

Complete information as to operating conditions, machine, setup, and the application of cutting fluid should accompany any product returned for inspection. This warranty shall not apply to any Allied Machine products which have been subjected to misuse, abuse, improper operating conditions, improper machine setup or improper application of cutting fluid or which have been repaired or altered if such repair or alteration, in the judgement of Allied Machine, would adversely affect the performance of the product.

THIS WARRANTY IS IN LIEU OF ALL OTHER WARRANTIES, EXPRESS OR IMPLIED, INCLUDING ANY IMPLIED WARRANTY OF MERCHANTABILITY OR FITNESS FOR A PARTICULAR PURPOSE. Allied Machine shall have no liability or responsibility for any claim, whether in contract, tort or otherwise, for any loss or damage arising out of, connected with, or resulting from the manufacture, sale, delivery or use of any product sold hereunder, in excess of the cost of replacement or repair as provided herein.

Allied Machine shall not be liable in contract or in tort (including, without limitation, negligence, strict liability or otherwise) for economic losses of any kind or for any special, incidental, indirect, consequential, punitive or exemplary damages arising in any way out of the performance of, or failure to perform this agreement.

ALL PRICES, DELIVERIES, DESIGNS, AND MATERIALS ARE SUBJECT TO CHANGE WITHOUT NOTICE.



Allied Machine & Engineering  
is registered to  
ISO 9001:2015 by DQS



Wohlhaupter GmbH  
is registered to  
ISO 9001:2015 by QA TECHNICH

## Deutschland | Österreich | Schweiz

**Wohlhaupter GmbH**  
Maybachstraße 4  
72636 Frickenhausen  
Germany

**Telefon:**  
+49 (0) 7022 408-0  
**Email:**  
info@wohlhaupter.de  
**Web:**  
www.wohlhaupter.com

## Europa

**Allied Machine & Engineering Co. (Europe) Ltd.**  
93 Vantage Point  
Pensnett Estate  
Kingswinford  
West Midlands  
DY6 7FR England

**Telefon:**  
+44 (0) 1384 400900  
**Email:**  
enquiries.eu@alliedmachine.com  
**Web:**  
www.alliedmachine.com

## Vereinigte Staaten

**Allied Machine & Engineering**  
120 Deeds Drive  
Dover OH 44622  
United States

**Telefon:**  
+1 330 343 4283  
**Fax:**  
+1 330 602 3400

**Allied Machine & Engineering**  
485 W Third Street  
Dover OH 44622  
United States

**Telefon:**  
+1 330 343 4283  
**Fax:**  
+1 330 364 7666  
(Engineering Dept.)

## Asien

**Wohlhaupter India Pvt. Ltd.**  
B-23, 2nd Floor  
B Block Community Centre  
Janakpuri, New Delhi - 110058  
India

**Telefon:**  
+91 11 41827044



台北: 02-27030193  
台中: 04-24636890

Website: [www.gcarbide.com](http://www.gcarbide.com)

**www.wohlhaupter.com**

90200 06.2018  
Printed in Germany - Technische Änderungen vorbehalten

Holemaking Solutions for Today's Manufacturing